



# AUTOMATE™

A DIVISION OF ROLLEASE ACMEDA

## Quick Programming Guide



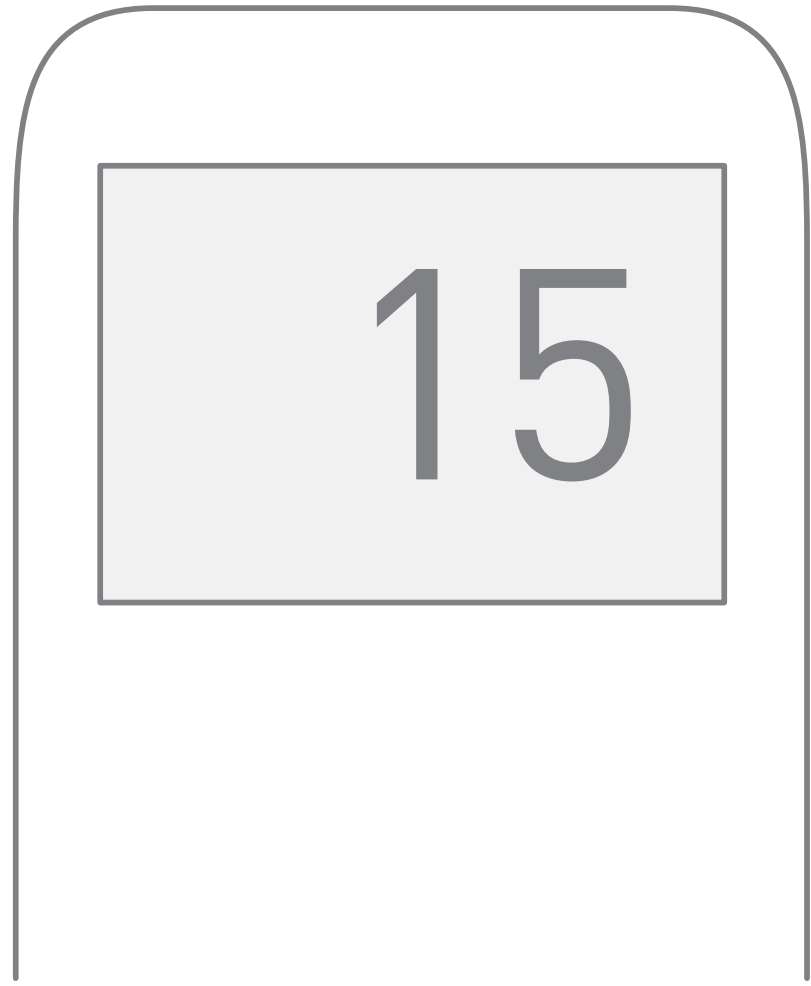

# 1. Pair shade to remote

Select channel on controller.

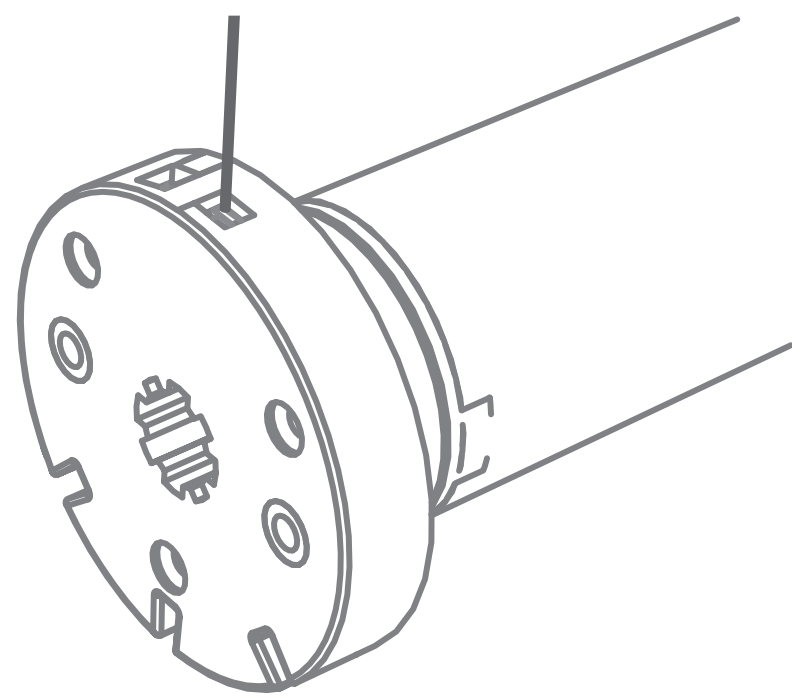

Hold **P1** button on motor head.



Release **P1** button on motor head.



Hold **STOP** on controller.

## MOTOR RESPONSE

---



## 2. Change motor direction

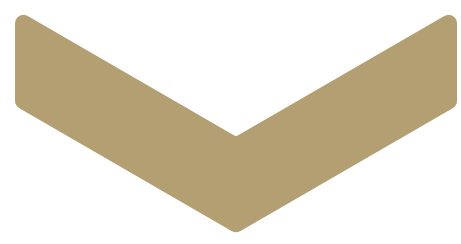
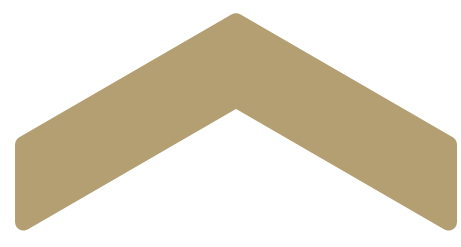

To reverse shade direction, hold both **UP** and **DOWN** until the motor responds.

CH

MOTOR RESPONSE

---

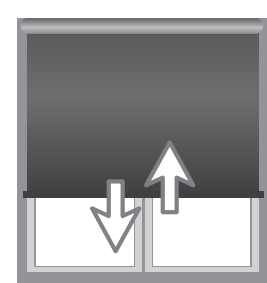

JOG  
X1



BEEP  
X1

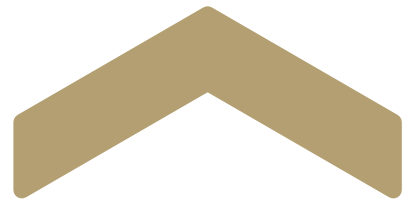

CH

## 3. Set top limit

To save upper limit,  
hold both **UP** and **STOP**.

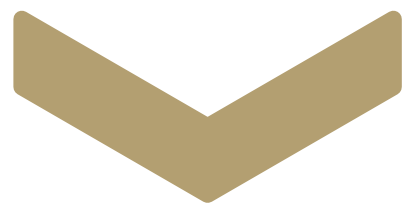

CH

## Set lower limit

To save lower limit,  
hold both **DOWN** and **STOP**.

MOTOR RESPONSE

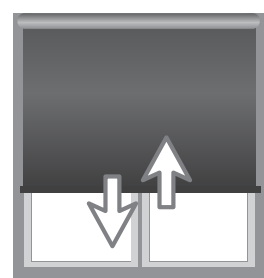

JOG  
X2



BEEP  
X3

# 4. Adjust lower limit



Hold both **DOWN** and **STOP** on controller.



Move shade to desired lowest position by pressing the **DOWN** arrow.

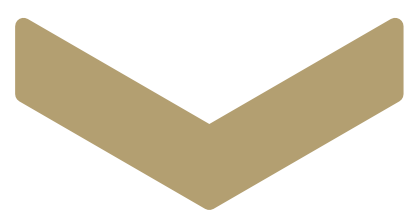

To save lower limit, hold both **DOWN** and **STOP**.



## MOTOR RESPONSE

---



# 5. Adjust upper limit

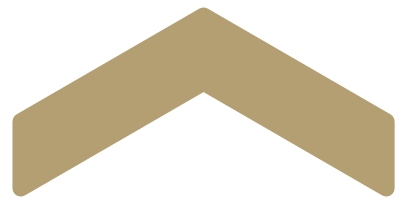

Hold both **UP** and **STOP** on controller.

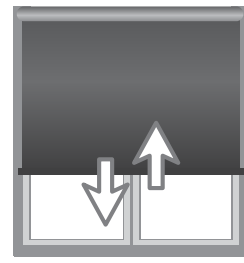

JOG  
**X1**



BEEP  
**X1**

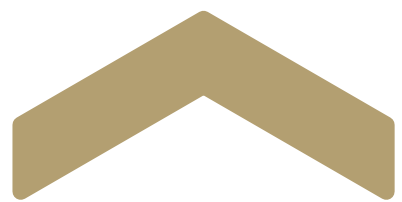

Move shade to desired upper position by pressing the **UP** arrow.

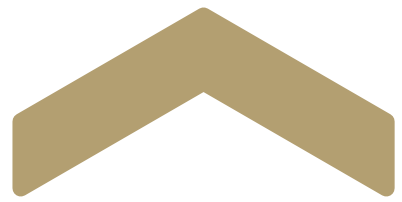

To save upper limit, hold both **UP** and **STOP**.

## MOTOR RESPONSE

---

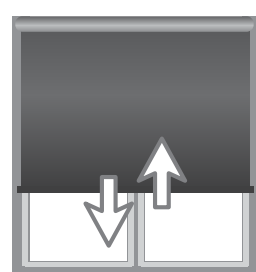

JOG  
**X2**



BEEP  
**X3**

*\*Not required for setup*



## 6. Set/Delete a Favorite Position

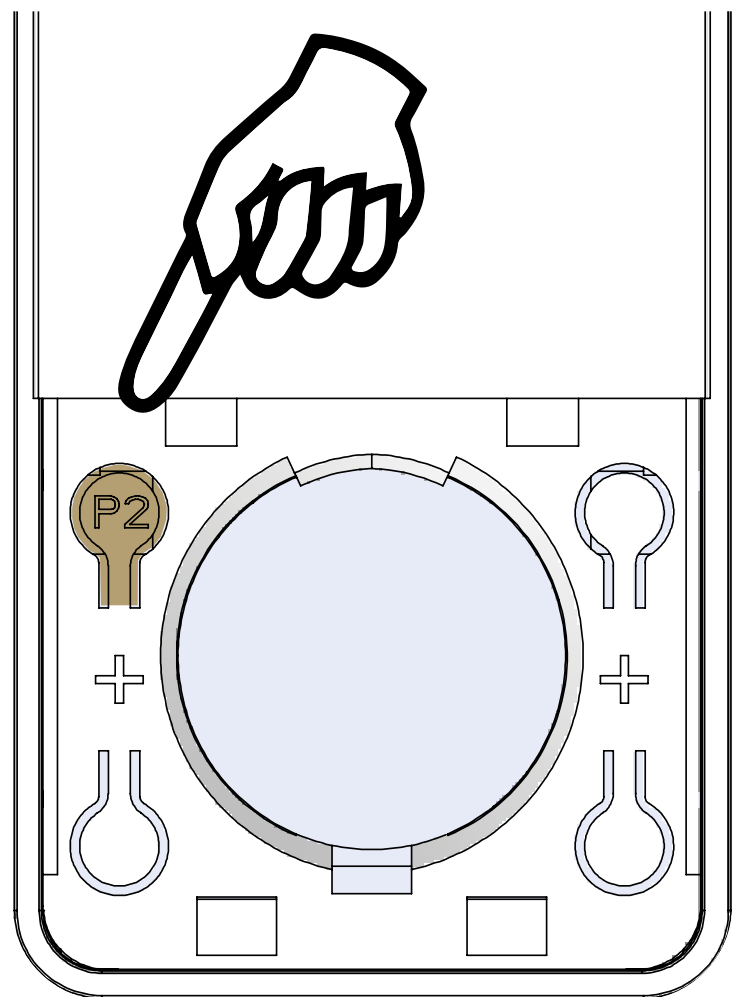

Press **P2** on controller.

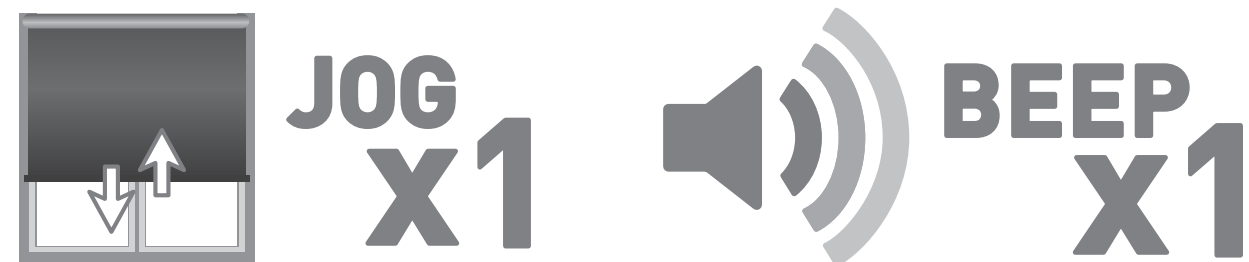

Press **STOP** on controller.



Press **STOP** on controller.

MOTOR RESPONSE

---



*\*Not required for setup*

# 7. Create/Delete groups using P2

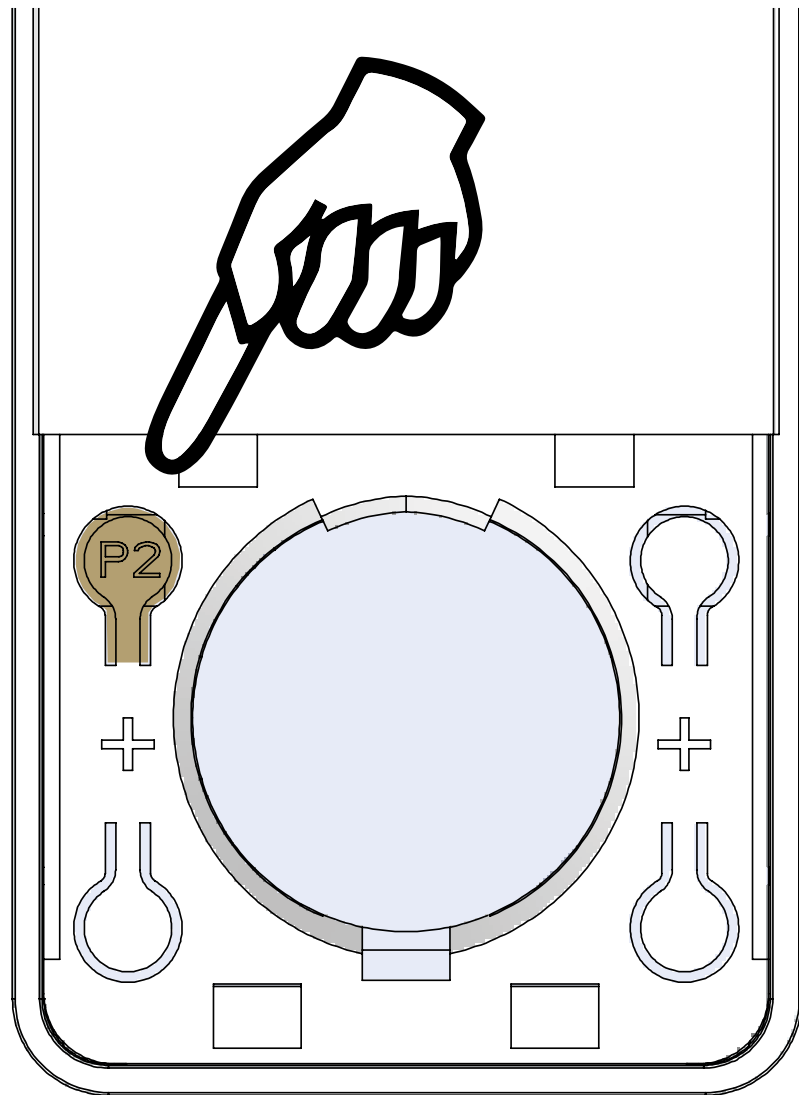

Press **P2** on controller **A**.



Press **P2** on controller **A**.

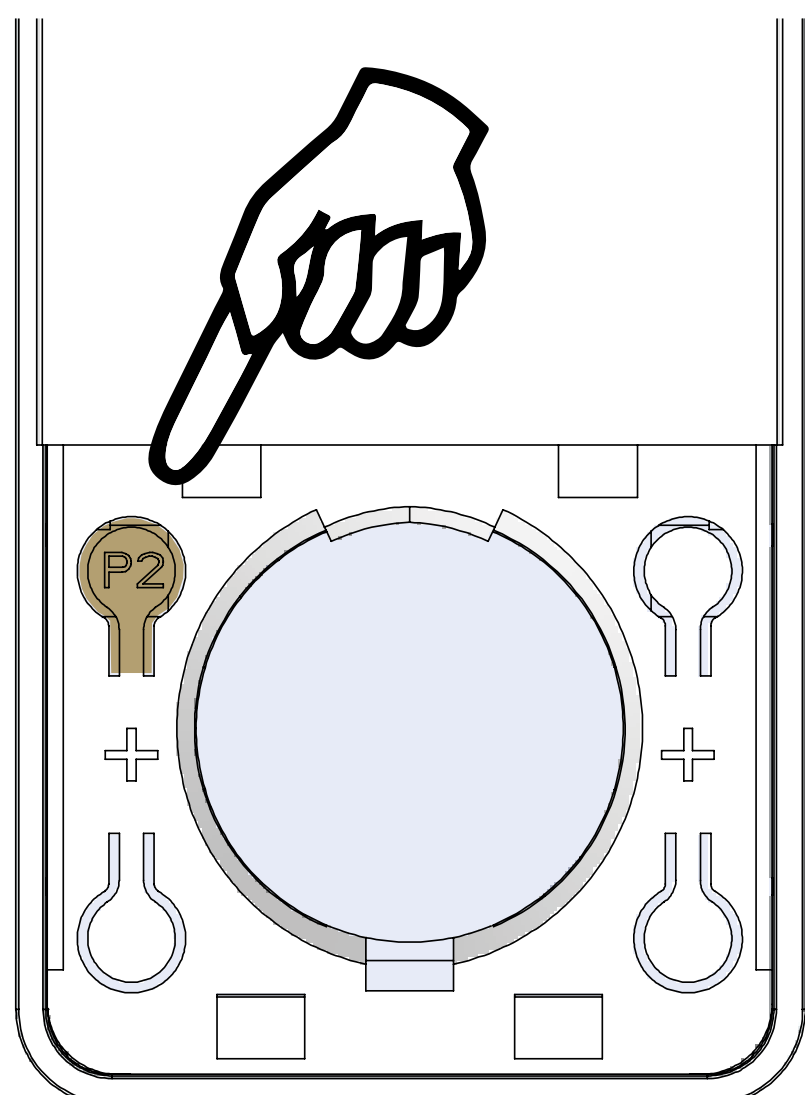

Press **P2** on controller **B**.

MOTOR RESPONSE



*\*Not required for setup*



# 8. Adjust Motor Speed

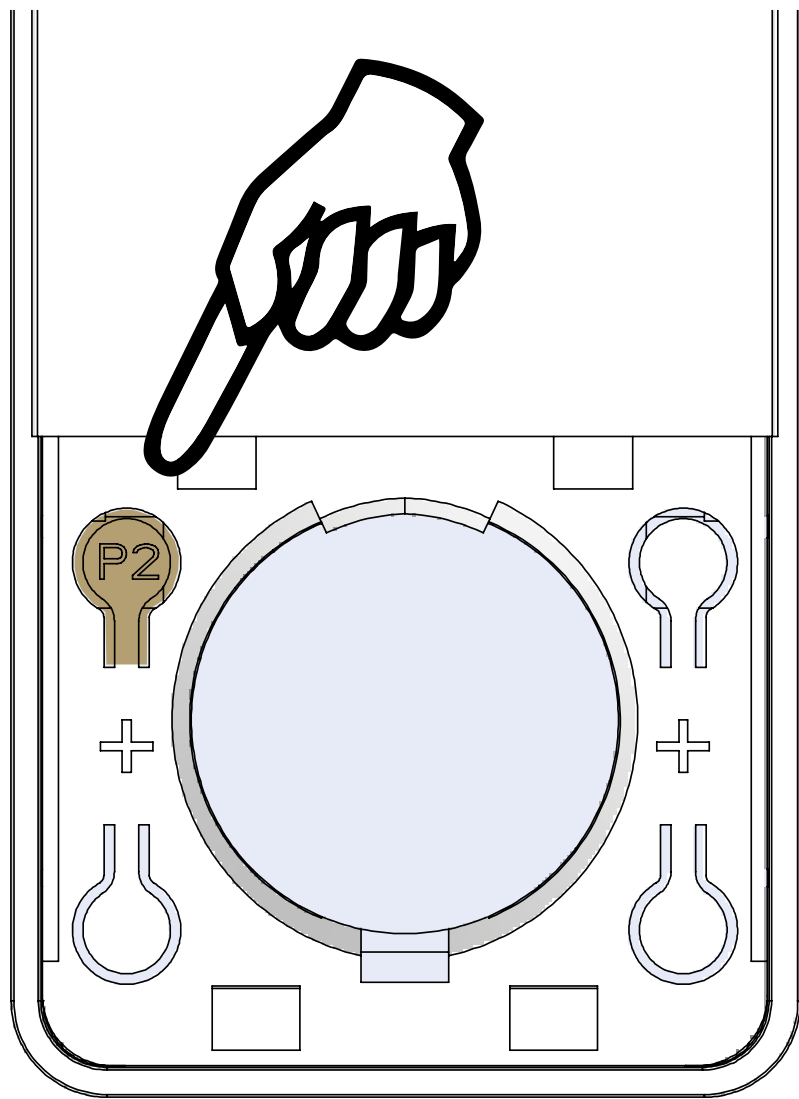

Press **P2** on controller.

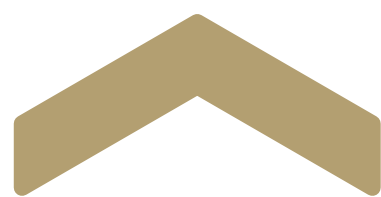
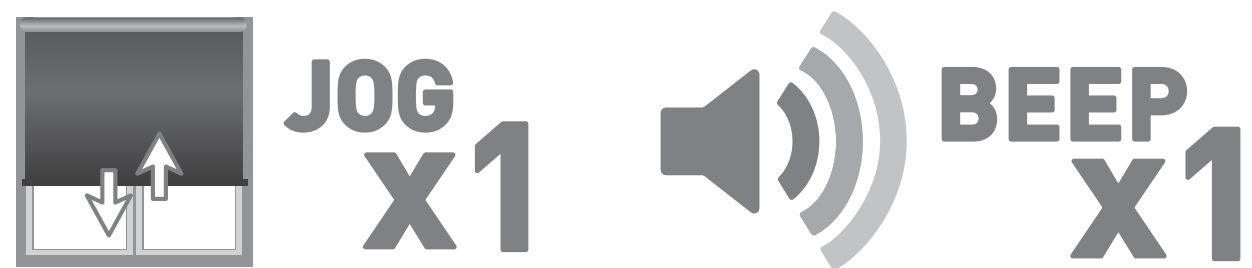

Press **UP** on controller.

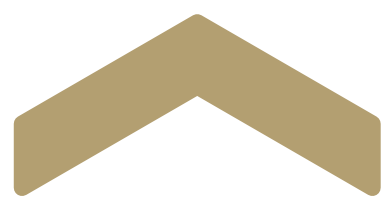

Press **UP** on controller.

MOTOR RESPONSE

---



*\*Not required for setup*

# 9.Lock Remote

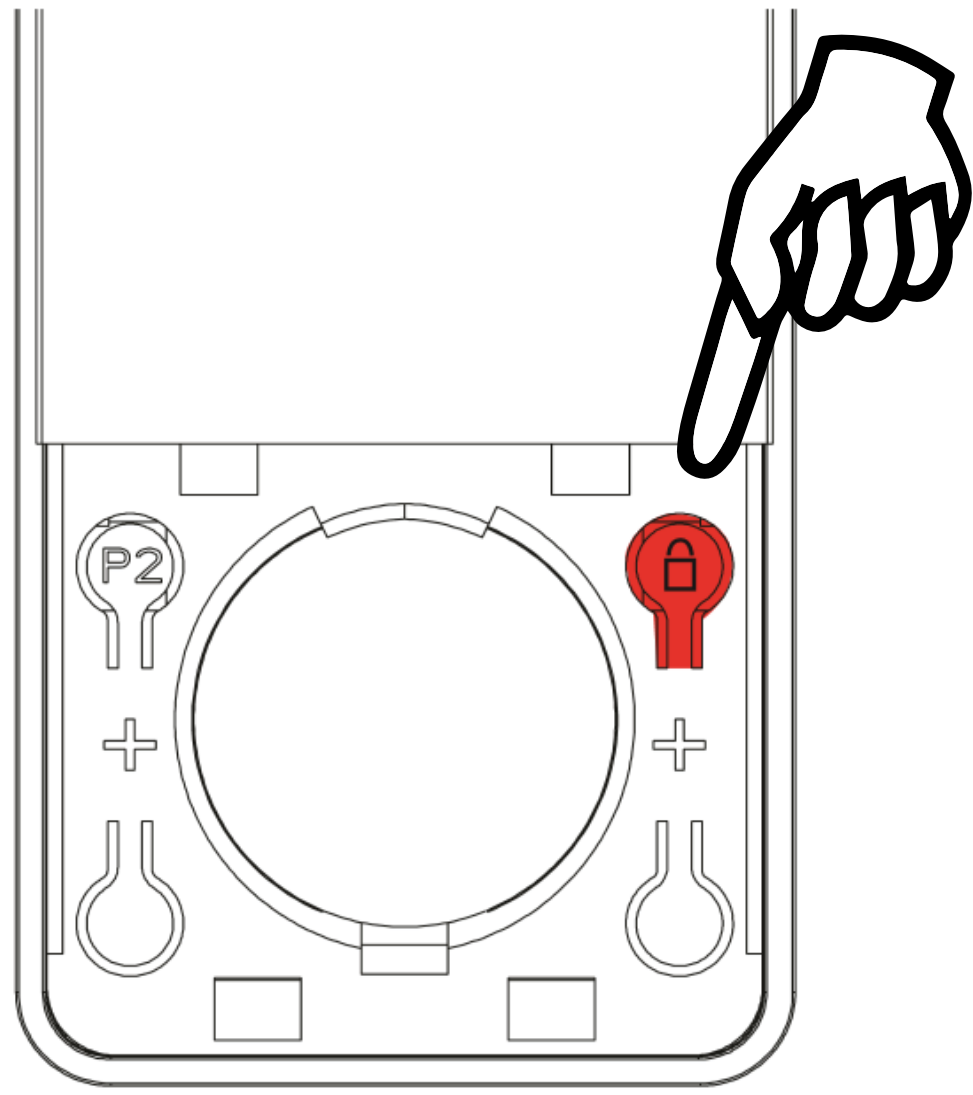

To switch modes, hold right **LOCK** button for **5 seconds**.

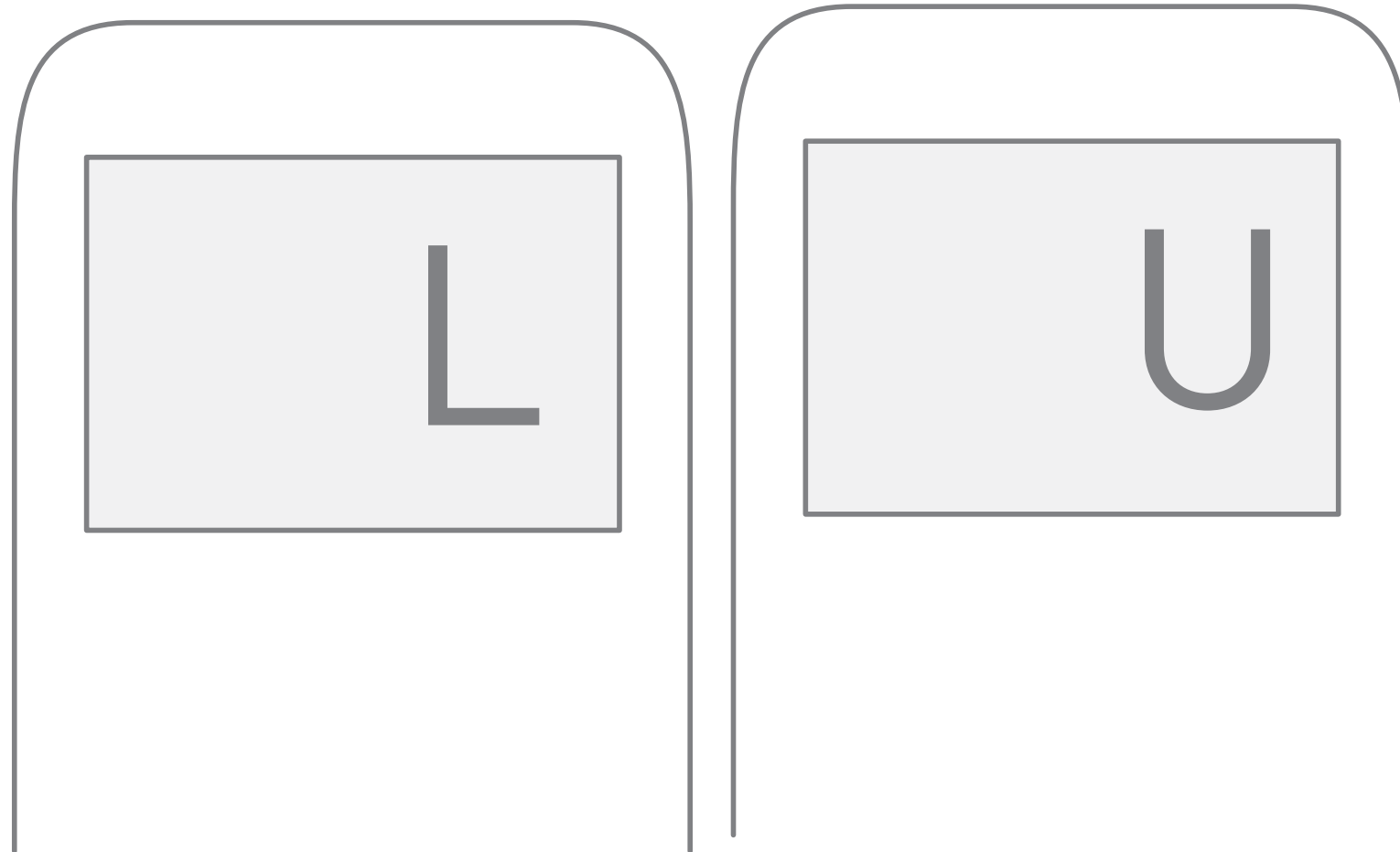

**For 15 CH**

LCD displays “**L**” when locked,  
LCD displays “**U**” when unlocked.

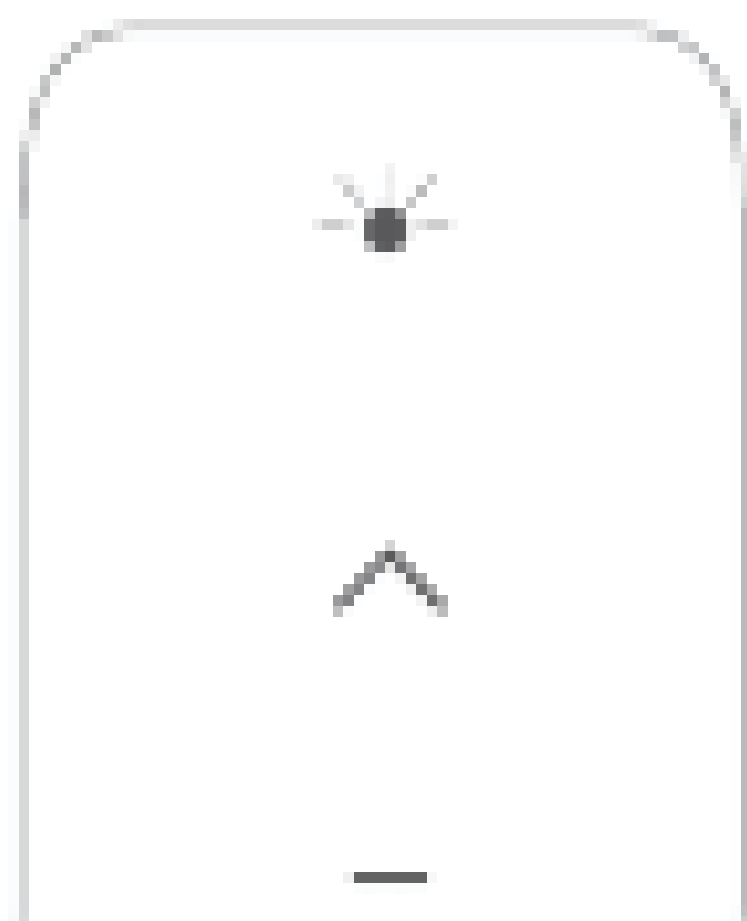

**For 1 CH**

LED solid on when locked  
LED blinking when unlocked

# 10.Hide Channels

Your multi channel remote can be configured to have anywhere between 1 or 15 visible channels. Inactive channels will not be visible when scrolling through the CH selection.



**CH**

Press **"STOP"** and **"CH"**



**CH**

Continue to hold **"CH"** and press **"UP"** or **"DOWN"** to select channels

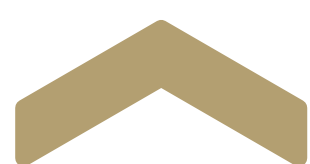

Press **"STOP"** to lock in

*\*Not required for setup*

# 11. Setting Modes

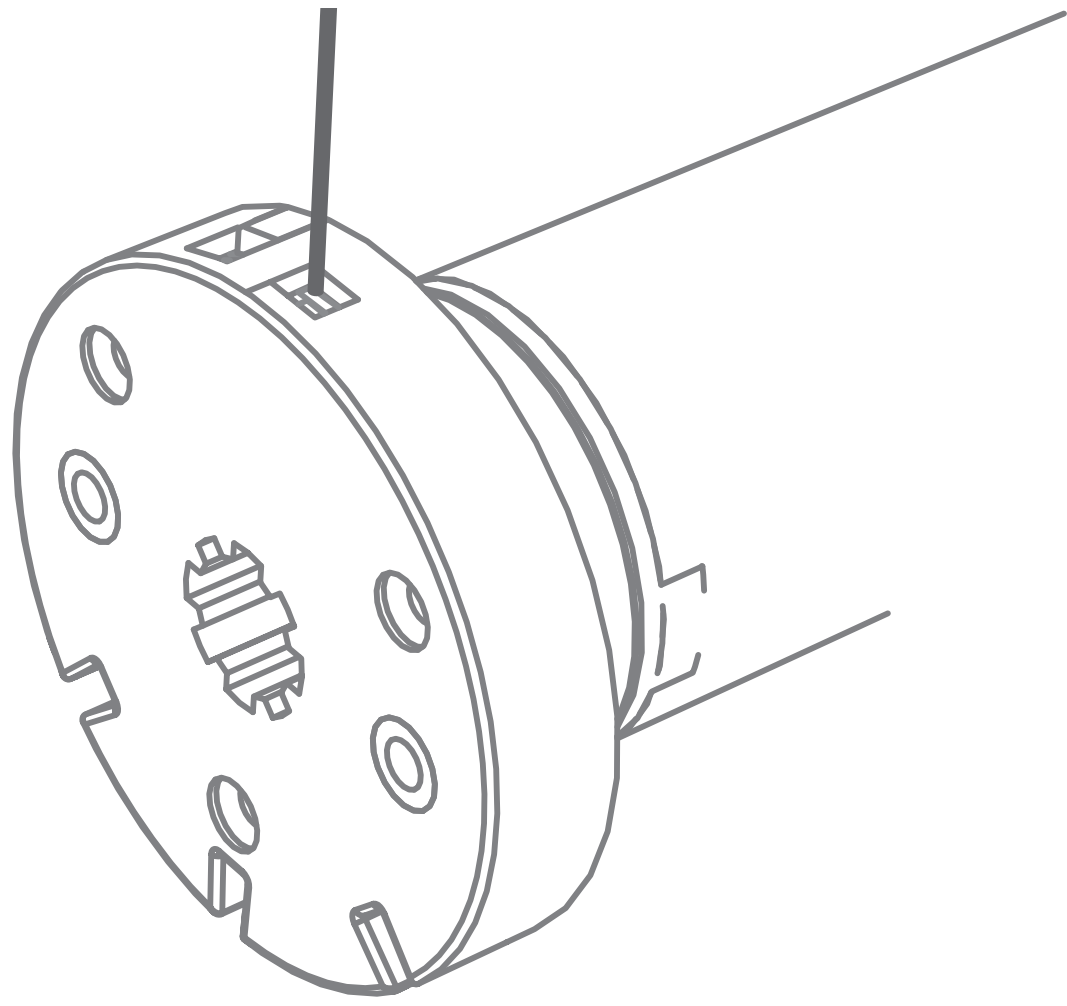

The **P1 Button** is utilized to administer motor configurations as described below.

Hold **P1 button** on motor head

## ACTIVE PAIRING MODE

---

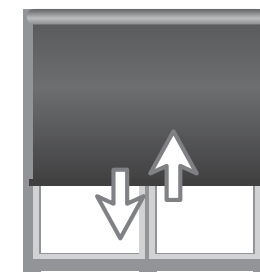

**JOG  
X1**

## SLEEP MODE

---

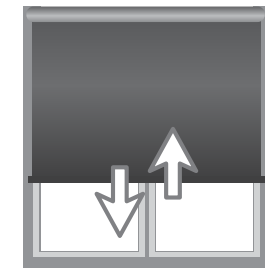

**JOG  
X2**

## REVERSE DIRECTION

---

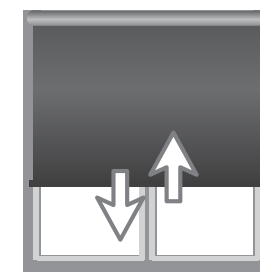

**JOG  
X3**

## RESET TO FACTORY SETTINGS

---

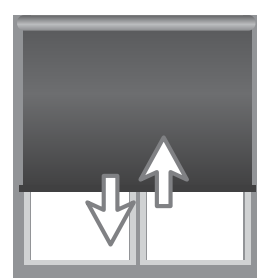

**JOG  
X4**



**BEEP  
X4**

*\*Not required for setup*

# 12.Step Mode

Default motor mode is Roller after initial Limits have been set, use following steps to change to Step Mode.

Hold **UP & DOWN**  
on controller

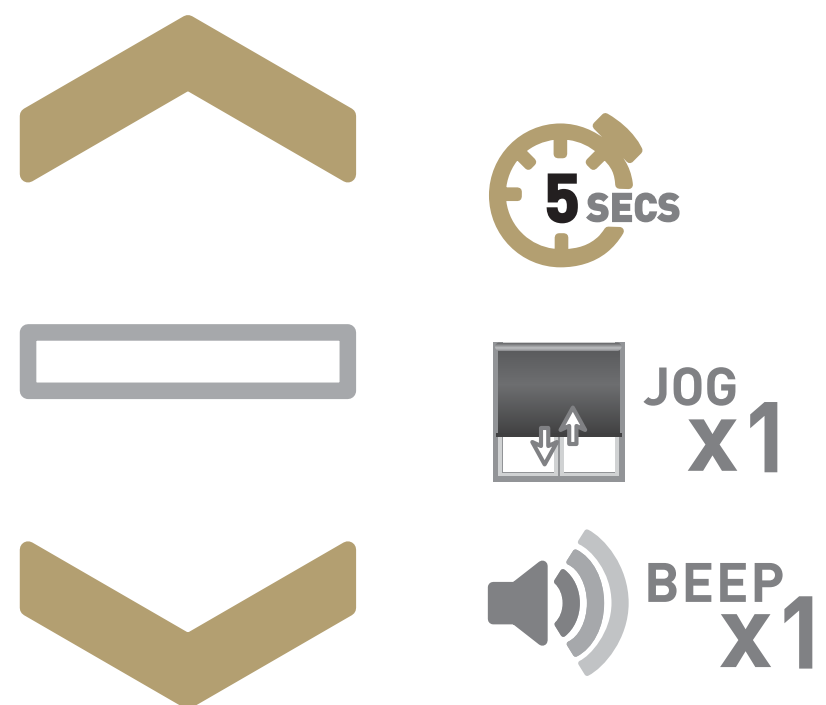

Press **STOP**  
on controller

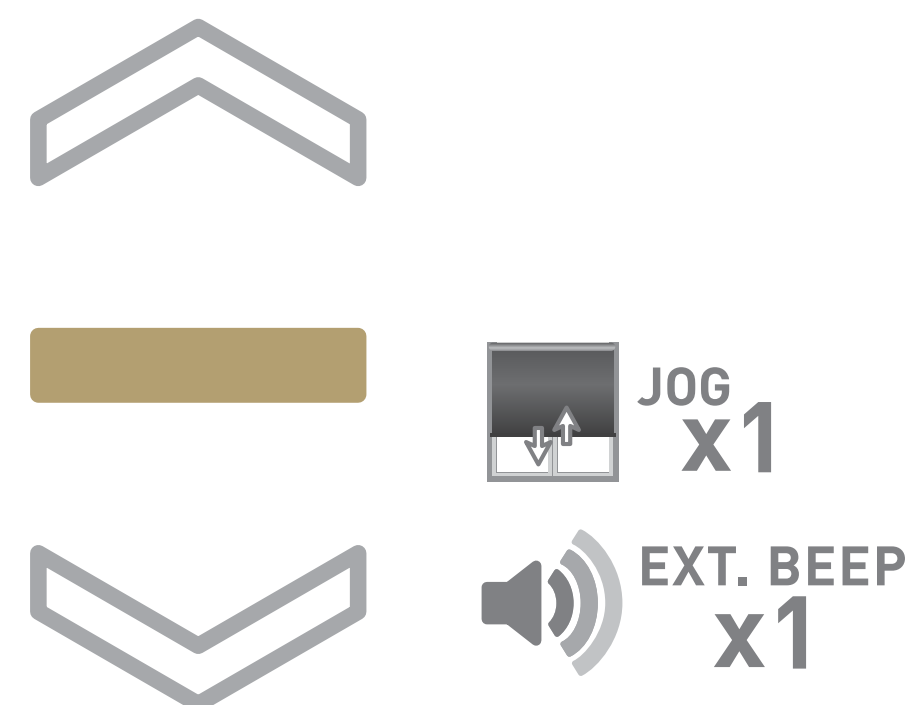

If motor is in Step Mode, use following steps to change to Roller Mode

Hold **UP & DOWN**  
on controller

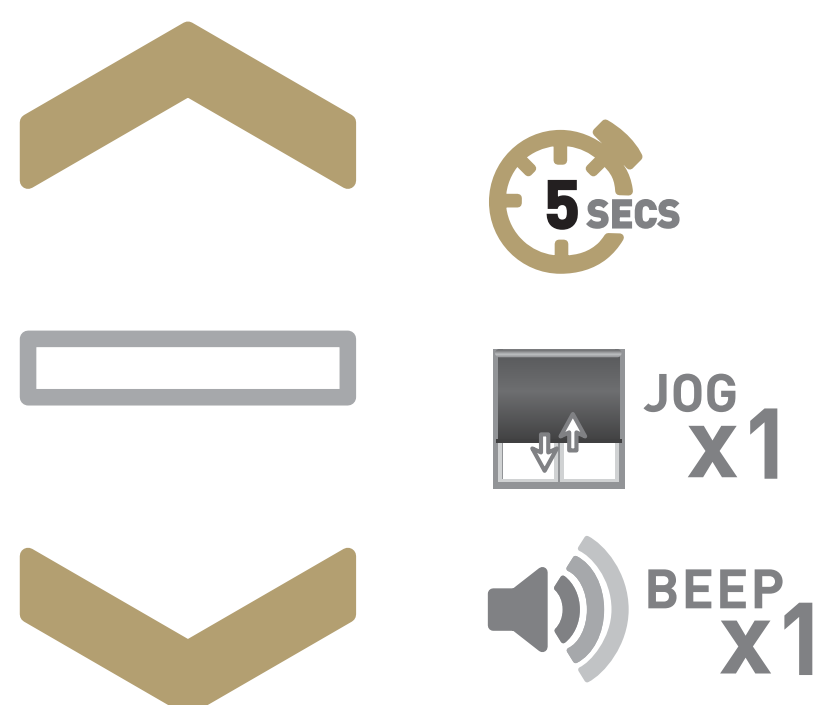

Press **STOP**  
on controller

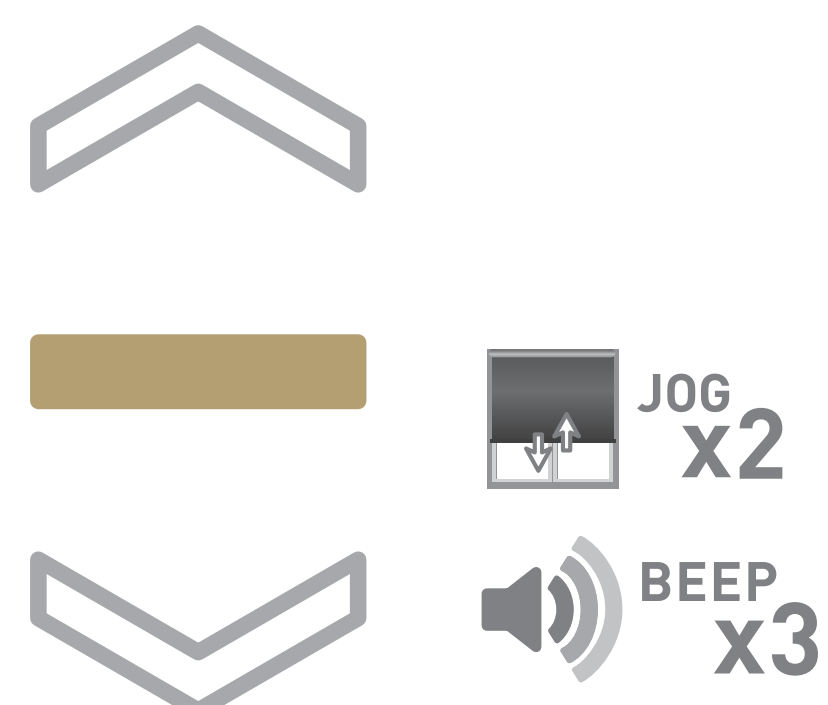

*\*Not required for setup*

## ROOMS

Group Automate shades by room and conveniently control them accordingly.

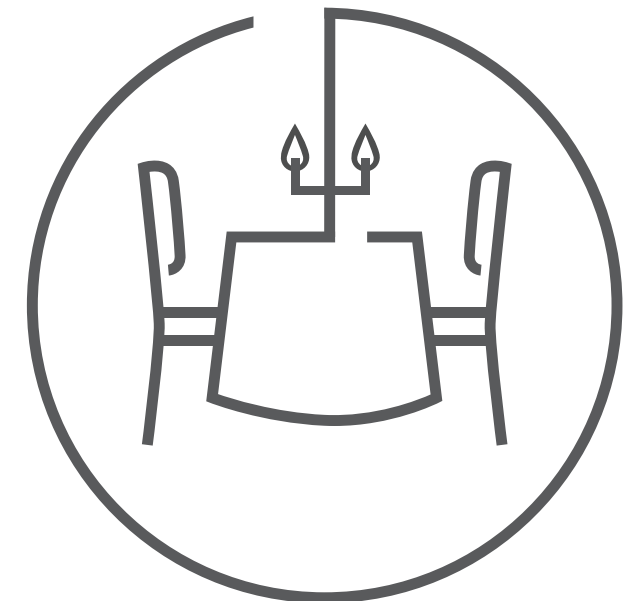

---

## SCENES

Personalise shade control and organise how your shades operate by specific daily events.

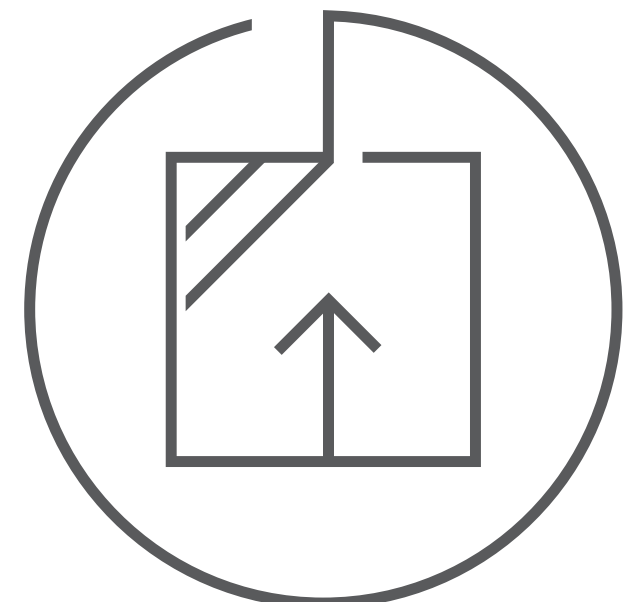

---

## TIMERS

Set and forget. Lower, raise and activate shade scenes automatically at the optimal time.

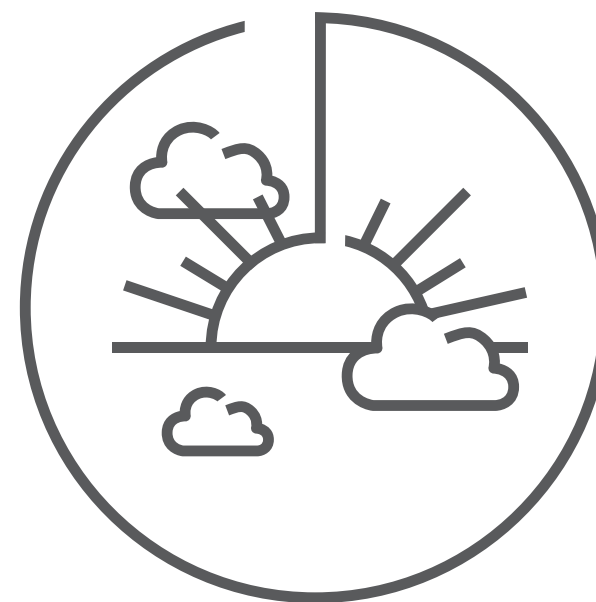

---

## MULTIPLE SHADE TYPES

Awnings, Roller shades, External shades, Cellular ... Control every shade type from one screen.

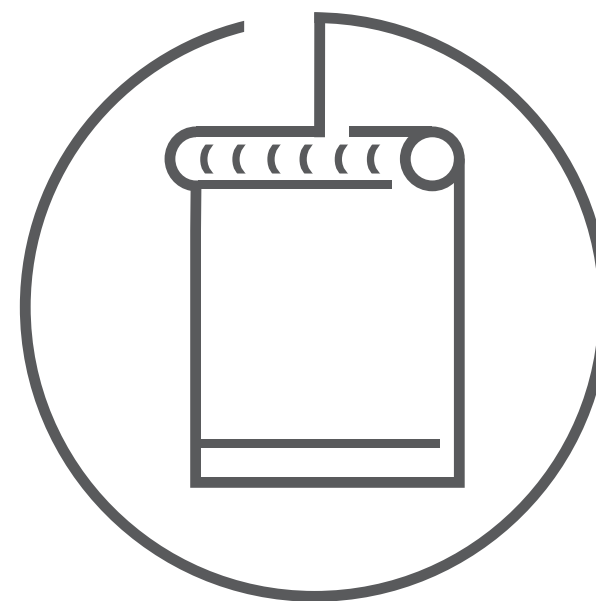



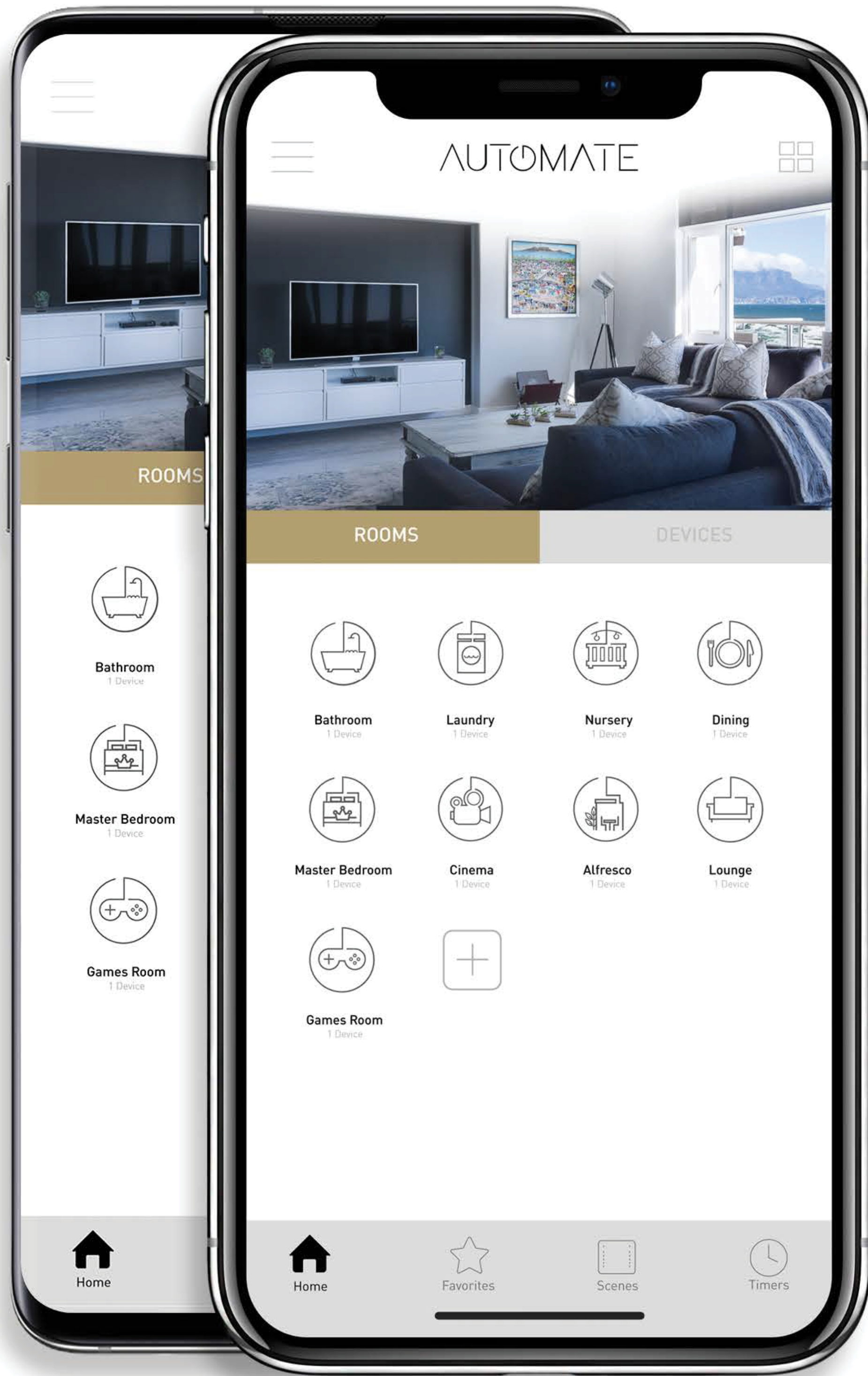

Voice Control



Home Automation Integration

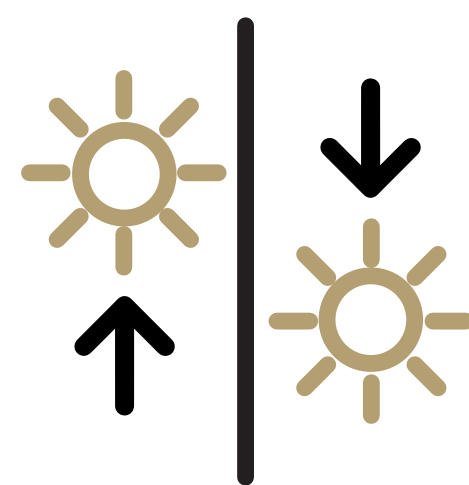

Sunrise & Sunset Detection



Live Feedback

# AUTOMATE™

A DIVISION OF ROLLEASE ACMEDA

## +1 203-590-5318

[ustechsupport@rolleasacmeda.com](mailto:ustechsupport@rolleasacmeda.com)



---

[automateshades.com](http://automateshades.com)

v 2020.03

MK91-9999-AUTPOC