

## AX30/AX50 EXTERNAL SHADE MOTOR



433 Mhz  
Bi-Directional



Electronic  
Limit



Favorite  
Position



Automate Radio  
Communication



Impact  
Detection

---

AUTOMATE | AX30/AX50 External Shade Motor combine the simple, intuitive features of ARC "Automate Radio Communication" with the higher lifting capacity for larger shade applications.

# CONTENTS

<b>1</b>	<b>ASSEMBLY</b>	<b>5</b>	<b>8</b>	<b>GENERAL INSTRUCTIONS</b>	<b>19</b>
<b>2</b>	<b>WIRING</b>	<b>6</b>	8.1	Adjust upper limit	19
2.1	EU/AU Motor	6	8.2	Adjust lower limit	19
2.2	US Motor	6	8.3	Delete upper/lower limits	20
<b>3</b>	<b>P1 BUTTON FUNCTIONS</b>	<b>7</b>	8.4	Add controller and channel	20
3.1	Motor state test	7	8.4.1	Using P2 button on existing controller to add a new controller or channel	20
3.2	Motor configuration options	7	8.4.2	Using a pre-existing controller to add or delete a controller or channel	21
<b>4</b>	<b>MODES</b>	<b>8</b>	8.5	Favorite positioning	21
4.1	Selectable modes	8	8.5.1	Set a favorite position	21
<b>5</b>	<b>FOLDING ARM AWNING – OPEN SYSTEM</b>	<b>9</b>	8.5.2	Send shade to favorite position	22
5.1.	Pair motor with controller	9	8.5.3	Delete favorite position	22
5.2	Check motor direction	10	8.6	Sleep mode	22
5.3	Change motor direction	10	8.7	Reset to factory settings via remote	23
5.4	Set limits	11	8.8	Sensor function	23
<b>6</b>	<b>FOLDING ARM AWNING – CASSETTE SYSTEM</b>	<b>12</b>	8.8.1	Sensor prioritize function	23
6.1	Pair motor with controller	12	<b>9</b>	<b>SUN AND WIND SENSOR</b>	<b>24</b>
6.2	Check motor direction	13	9.1	Activate/Deactivate Sun and Wind sensor functionality on the Motor	24
6.3	Change motor direction	13	9.2	Pairing Sun and Wind sensor to Motor	24
6.4	Select motor mode	14	<b>10</b>	<b>TROUBLESHOOTING</b>	<b>25</b>
6.5	Set limits	14			
<b>7</b>	<b>VERTICAL DROP MODE</b>	<b>15</b>			
7.1	Pair motor with controller	15			
7.2	Check motor direction	16			
7.3	Select motor mode	17			
7.4	Set limits	17			
7.5	Impact detection (only with Zipscreen)	18			
7.6	Activate/Deactivate Impact Detection Mode	18			

# SAFETY INSTRUCTIONS

## WARNING: Important safety instructions to be read before installation.

Incorrect installation can lead to serious injury and will void manufacturer's liability and warranty.

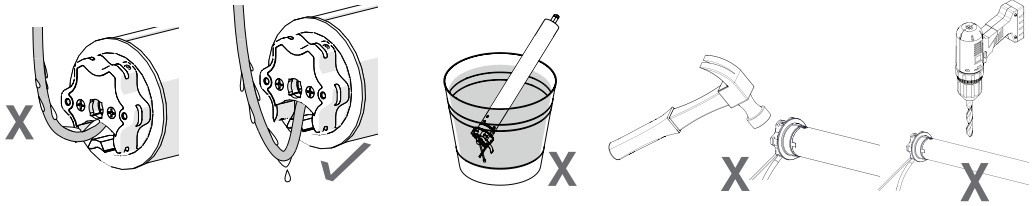

## CAUTION

- Do not expose to moisture or extreme temperatures.
- Do not allow children to play with this device.
- Use or modification outside the scope of this instruction manual will void warranty.
- Installation and programming to be performed by a suitably qualified installer.
- For use within tubular blinds.
- Ensure correct crown and drive adaptors are used for the intended system.
- Keep antenna straight and clear from metal objects
- Do not cut the antenna.
- Use only Rollease Acmeda hardware.
- Before installation, remove any unnecessary cords and deactivate any equipment not needed for powered operation.
- Ensure torque and operating time is compatible with end application.
- Do not expose the motor to water or install in humid or damp environments.
- Motor is to be installed in horizontal application only.
- Do not drill into motor body.
- The routing of cable through walls shall be protected by isolating bushes or grommets.
- Route motor cable to create a drip loop (see above)
- Ensure power cable and aerial is clear and protected from moving parts.
- If cable or power connector is damaged do not use.

## Important safety instructions to be read prior to operation.

- It is important for the safety of persons to follow the enclosed instructions. Save these instructions for future reference.
- Persons (including children) with reduced physical, sensory or mental capabilities, or lack of experience and knowledge should not be allowed to use this product.
- Keep remote controls away from children.
- Frequently inspect for improper operation. Do not use if repair or adjustment is necessary.
- Keep motor away from acid and alkali.
- Do not force the motor drive. Keep clear when in operation.



Do not dispose of in general waste.

Please recycle batteries and damaged electrical products appropriately.

# SAFETY INSTRUCTIONS

## Statement Regarding FCC Compliance

This device complies with Part 15 of the FCC Rules. Operation is subject to the following two conditions:

- (1) This device may not cause harmful interference, and
- (2) This device must accept any interference received, including interference that may cause undesired operation.

### Note:

This equipment has been tested and found to comply with the limits for a Class B digital device, pursuant to Part 15 of the FCC Rules. These limits are designed to provide reasonable protection against harmful interference in a residential installation. This equipment generates, uses and can radiate radio frequency energy and, if not installed and used in accordance with the instructions, may cause harmful interference to radio communications. However, there is no guarantee that interference will not occur in a particular installation. If this equipment does cause harmful interference to radio or television reception, which can be determined by turning the equipment off and on, the user is encouraged to try to correct the interference by one or more of the following measures:

- Reorient or relocate the receiving antenna.
- Increase the separation between the equipment and receiver.
- Connect the equipment into an outlet on a circuit different from that to which the receiver is connected.
- Consult the dealer or an experienced radio/TV technician for help.
- Any changes or modifications not expressly approved by the party responsible for compliance could void the user's authority to operate the equipment.

## Statement Regarding IC Compliance

1. This device complies with Industry Canada RSS standard(s). Operation is subject to the following two conditions: (1) this device may not cause interference, and (2) this device must accept any interference, including interference that may cause undesired operation of the device.

2. Changes or modifications not expressly approved by the party responsible for compliance could void the user's authority to operate the equipment.

### -French:

Le présent appareil est conforme aux CNR d'Industrie Canada applicable aux appareils radio

Exempts de licence. L'exploitation est autorisée aux deux conditions suivantes :

(1) l'appareil ne doit pas produire de brouillage, et (2) l'utilisateur de l'appareil doit accepter tout brouillage radioélectrique subi, même si le brouillage est susceptible d'en compromettre le fonctionnement."

CAN ICES-3 (B)/NMB-3(B)



Do not dispose of in general waste.  
Please recycle batteries and damaged  
electrical products appropriately.



# 1 ASSEMBLY

Please refer to Rollease Acmeda System Assembly Manual for full assembly instructions relevant to the hardware system being used, including recommended crown, drive and bracket adapter kits.

## Step 1.

Cut roller tube to required length.



### IMPORTANT

Impact detection does not require a 2 piece drive set. The use of a standard 1 part drive adapter is compatible. Zipscreen is needed to let the impact transmit to the top during downward movement. The top tube must be able to freely rotate ~ 5 degrees after installation.

## Step 2.

Ensure roller tube is clean and free from burrs.

## Step 3.

Fit required crown, drive and bracket adapters. Tube must be close fitting with chosen crown and drive adapters.

## Step 4.

Slide Motor into tube.

Insert by aligning key-way in crown and drive wheel into the tube.

## Step 5.

Mount motorized tube onto brackets.

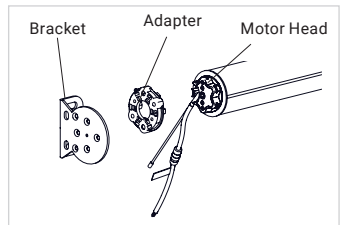
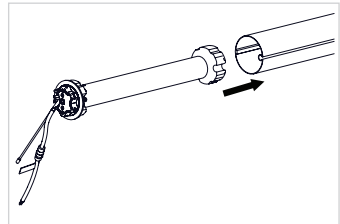
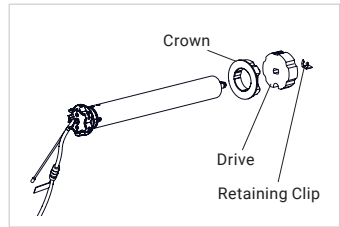
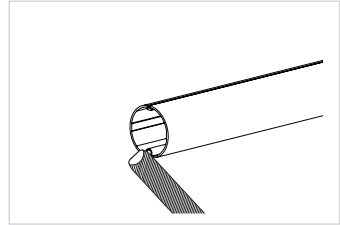
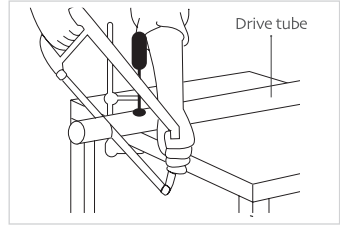

## 2 WIRING

### 2.1 EU/AU Motor

Disconnect the mains power supply.

Connect the motor according to the information in the table below.



Ensure cable is kept clear of fabric.

Ensure antenna is kept straight and away from metal objects.

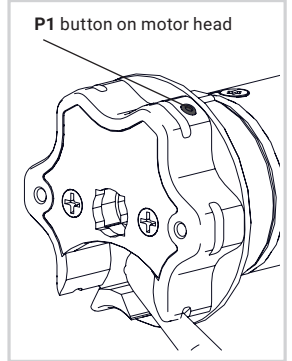
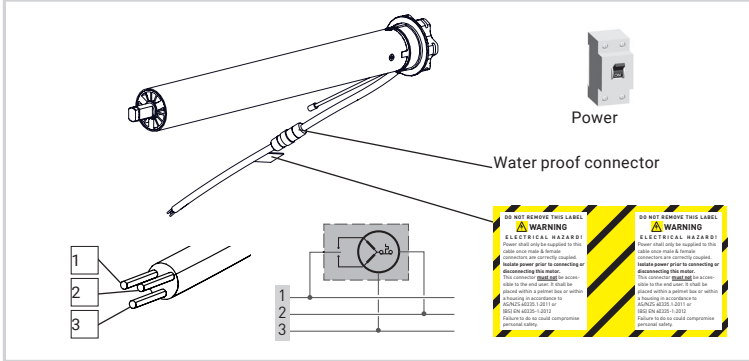

MOTOR	POWER	NEUTRAL	LIVE	EARTH	REGION
MT01-1145-069014	230V AC 50Hz	Blue	Brown	Yellow/Green	EU
MT01-1145-069016					
MT01-1145-069013	240V AC 50Hz				AU
MT01-1145-069015					

### 2.2 US Motor



Ensure cable is kept clear of fabric.

Ensure antenna is kept straight and away from metal objects.

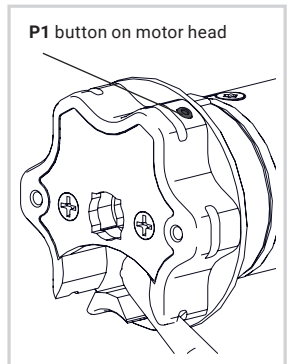
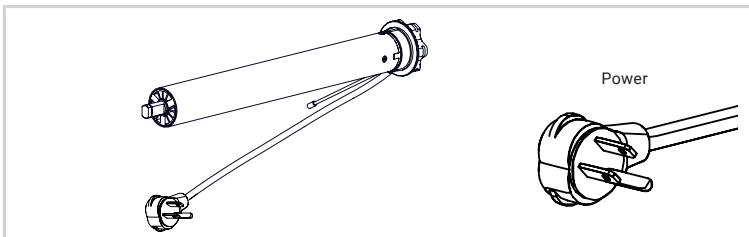

MOTOR	POWER CORD LENGTH	POWER	NEUTRAL	LIVE	EARTH
MT01-1145-069017	240in. (6096mm)	120V AC 60Hz	White	Black	Green
MT01-1145-069018					

# 3 P1 BUTTON FUNCTIONS

## 3.1 Motor state test

This table describes the function of a short **P1** Button press/release (<2 seconds) depending on current motor configuration.

P1 Press	Condition	Function Achieved	Visual Feedback	Audible Feedback	Function Described
Short Press	If limit is NOT set	None	No Action	None	No Action
	If limits are set	Operational control of motor, run to limit. Stop if running	Motor Runs	None	Operational control of motor after pairing and limit setting is completed first time
	If motor is in "Sleep Mode" & limits are set	Wake and control	Motor wakes and runs in a direction	None	Motor is restored from Sleep Mode and RF control is active

## 3.2 Motor configuration options

The **P1** Button is utilized to administer motor configurations as described below.

Hold **P1** button on motor head.

### Activate Pairing Mode



### Sleep Mode



### Reverse Direction



### Reset To Factory Settings



### P1 button on motor head

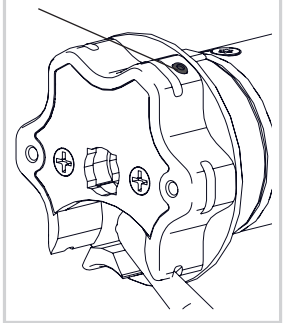

# 4 MODES

## 4.1 Selectable modes

### 1. FOLDING ARM AWNING – OPEN SYSTEM

Set Top and Bottom Limit Manually

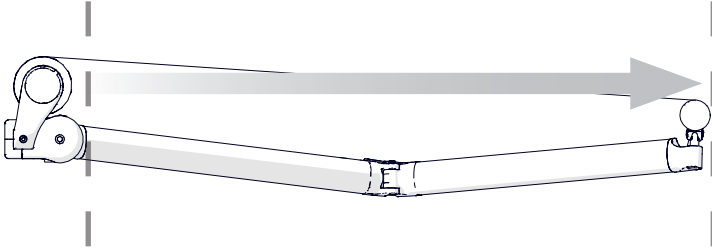

### 2. FOLDING ARM AWNING – CASSETTE SYSTEM

Set Bottom limit manually and Top limit is set automatically

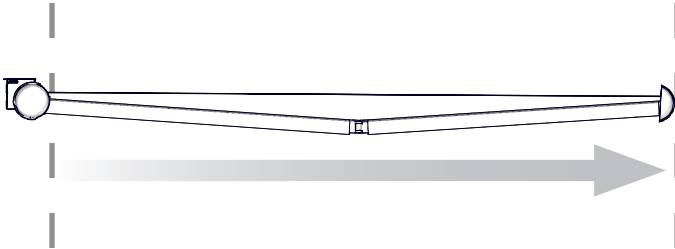

### 3. VERTICAL DROP MODE

Set Top and Bottom Limit Manually

Impact Detection can be turned on - Refer to section for impact detection.

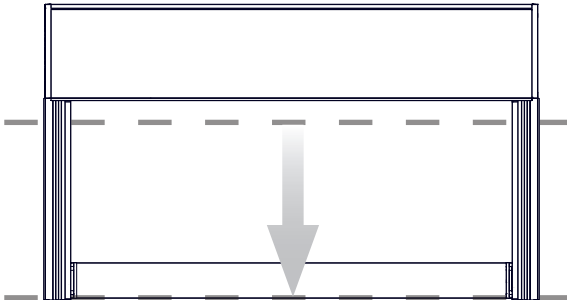



# 5 FOLDING ARM AWNING – OPEN SYSTEM

Note: For Cassette Mode and Vertical Drop Mode, refer to their respective sections.

## 5.1. Pair motor with controller

Select channel on controller.



**IMPORTANT**

Consult user manual for your controller for information on selecting channel.



**Motor is now in step mode and ready for setting limits**

Hold **P1** button on motor head.

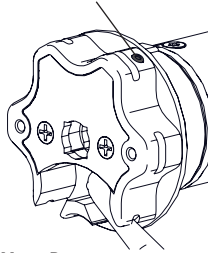

**Motor Response**



Hold **STOP** on controller within 4s



**Motor Response**



## 5.2 Check motor direction

Awning direction should be setup as below, so any paired sensors will activate correctly.

**DOWN** on the remote **OPENS** the Awning (awning moves in an outward direction).

E.g.

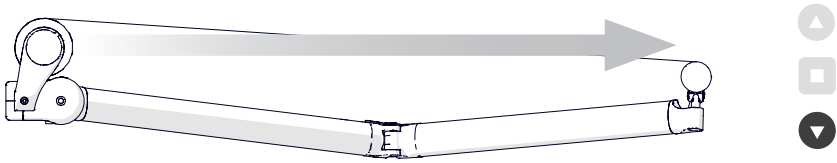

And **UP** on the remote **CLOSES** the Awning (awning moves in an inward direction).

E.g.

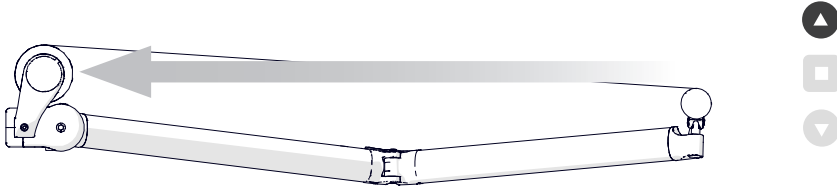

## 5.3 Change motor direction

To check travel direction of shade, press **UP** or **DOWN** on controller.

To reverse shade direction, hold both **UP** and **DOWN**. Until the motor responds.



**Quick Press** = Step

**Long Press** = Continuous Travel



**IMPORTANT**

Damage to shade may occur when operating motor prior to setting limits. Attention should be given.

**Motor Response**

Approx.



JOG X1



**IMPORTANT**

Reversing motor direction using this method is only possible during initial set-up

## 5.4 Set limits

Move shade to the desired highest or lowest position by pressing the **UP** or **DOWN** buttons on controller.

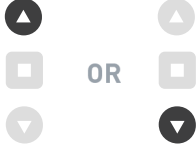

To save upper limit, hold **UP** and **STOP**.



To save lower limit, hold **DOWN** and **STOP**.



### IMPORTANT

Cycle shade up and down prior to setting limits to settle fabric

### Motor Response

Approx. 



### IMPORTANT

After setting limits, motor will automatically exit from initial set-up mode.

# 6 FOLDING ARM AWNING – CASSETTE SYSTEM

Note: For Non-Cassette Open Mode and Vertical Drop Mode, refer to section their respective sections.

## 6.1 Pair motor with controller

Select channel on controller.



### **IMPORTANT**

Consult user manual for your controller for information on selecting channel.

 **Motor is now in step mode and ready for setting limits**

Hold **P1** button on motor head.

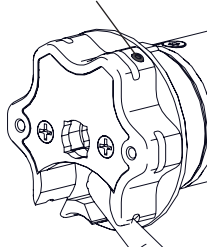

### **Motor Response**



Hold **STOP** on controller within 4s.



### **Motor Response**



## 6.2 Check motor direction

Awning direction should be setup as below, so any paired sensors will activate correctly.

**DOWN** on the remote **OPENS** the Awning (awning moves in an outward direction).

E.g.

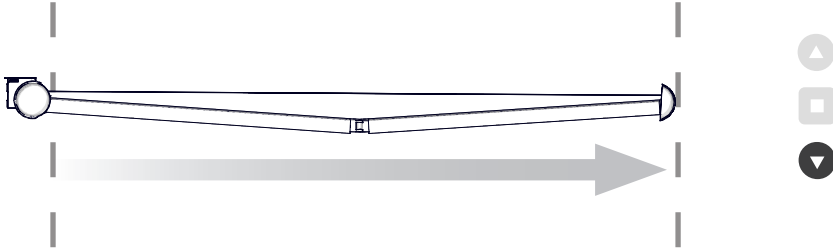

And **UP** on the remote **CLOSES** the Awning (awning moves in an inward direction).

E.g.

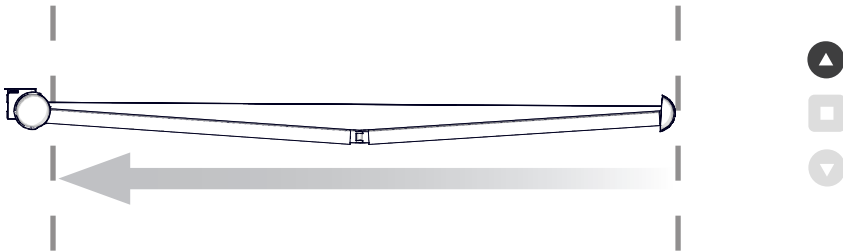

## 6.3 Change motor direction

To check travel direction of shade, press **UP** or **DOWN** on controller.

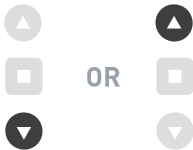

To reverse shade direction, hold both **UP** and **DOWN**.  
Until the motor responds.



**Quick Press** = Step  
**Long Press** = Continuous Travel

Motor Response

Approx.   JOG X1

### IMPORTANT

Damage to shade may occur when operating motor prior to setting limits. Attention should be given.

### IMPORTANT

Reversing motor direction using this method is only possible during initial set-up

## 6.4 Select motor mode

Now set the motor to cassette mode.

Press **P2** on controller.



Press **UP** on controller.



Press **UP** on controller.



Cassette Mode:

Motor Response



## 6.5 Set limits

### SET LOWER LIMIT IN CASSETTE MODE

Move shade to the desired lowest position by pressing the **UP** or **DOWN** buttons on controller.



To save lower limit, hold **DOWN** and **STOP**.



Motor Response



### SET UPPER LIMIT IN CASSETTE MODE

Press the **UP** button on the controller and the shade will retract until the terminal bar touches the

# 7 VERTICAL DROP MODE

Note: For Non-Cassette Open Mode and Cassette Mode, refer to their respective sections.

## 7.1 Pair motor with controller

Note: Ensure Motor is in factory default setting.

Select channel on controller.



Hold **P1** button on motor head.

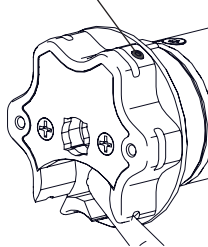

Hold **STOP** on controller within 4s.



### IMPORTANT

Consult user manual for your controller for information on selecting channel.

Motor Response



Motor Response



 **Motor is now in step mode and ready for setting limits**

## 7.2 Check motor direction

To check travel direction of shade, press **UP** or **DOWN** on controller.

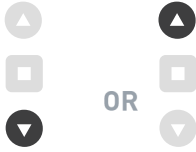

To reverse shade direction, hold both **UP** and **DOWN**.

Until the motor responds.



**Quick Press** = Step

**Long Press** = Continuous Travel

Motor Response



### IMPORTANT

Damage to shade may occur when operating motor prior to setting limits. Attention should be given.



### IMPORTANT

Reversing motor direction using this method is only possible during initial set-up



## 7.3 Select motor mode

Now set vertical drop mode.

Press **P2** on controller.

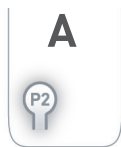

Press **UP** on controller.



Press **UP** on controller.



Perform sequence **2** Times - Motor will Jog/Beep at the end of each sequence.

Vertical Drop Mode:

Motor Response at the end of x2 sequence



## 7.4 Set limits

Move shade to the desired highest or lowest position by pressing the **UP** or **DOWN** buttons on controller.

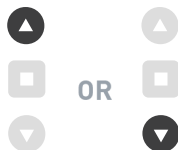

To save upper limit, hold **UP** and **STOP**.



To save lower limit, hold **DOWN** and **STOP**.



### IMPORTANT

Cycle shade up and down prior to setting limits to settle fabric

Motor Response



### IMPORTANT

After setting limits, motor will automatically exit from initial set-up mode.

## 7.5 Impact detection (only with Zipscreen)

Impact detection is deactivated by default. If an obstacle is detected twice in the shade path during downwards movement, the motor lifts the shade up ~ 7.87in. (20cm).

Top limit

Inactive zone of impact detection

2.62 x TUBE DIAMETER

Active zone of impact detection



Impact detection does not require a 2 piece drive set. The use of a standard 1 part drive adapter is compatible.

The top tube must be able to freely rotate ~ 5 degrees after installation. Zipscreen is needed to let the impact transmit to the top during downward movement.

Inactive zone of impact detection

2.62 x TUBE DIAMETER

Bottom limit

## 7.6 Activate/Deactivate Impact Detection Mode

The Impact Detection feature only works in the active zone during downward movement. This impact detection feature is deactivated by default. Repeat sequence to turn on or off as required.

Press **P2** on controller.

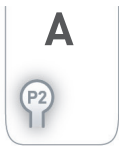

Press **DOWN** on controller.



Press **DOWN** on controller.



Motor Response



Motor Response



**Impact Detection ON**

Motor Response



**Impact Detection OFF**

Motor Response



### IMPORTANT

Impact detection does not require a 2 piece drive set. The use of a standard 1 part drive adapter is compatible. The top tube must be able to freely rotate ~ 5 degrees after installation. Zipscreen is needed to let the impact transmit to the top during downward movement.

# 8 GENERAL INSTRUCTIONS

## 8.1 Adjust upper limit

Hold **UP** and **STOP** on controller.



Move shade to the desired highest position by pressing the **UP** button.



To save upper limit, hold **UP** and **STOP**.



Motor Response



Motor Response



## 8.2 Adjust lower limit

Hold **DOWN** and **STOP** on controller.



Move shade to the desired lowest position by pressing the **DOWN** button.



To save lower limit, hold **DOWN** and **STOP**.



Motor Response



Motor Response



## 8.3 Delete upper/lower limits

Press **P2** on controller



Motor Response



Press **DOWN** on controller



Motor Response



Press **P2** on controller



Motor Response



## 8.4 Add controller and channel

### 8.4.1 Using P2 button on existing controller to add a new controller or channel

**A** = Existing controller or channel (to keep)

**B** = Controller or channel to add or remove

Press **P2** on controller **A**.



Motor Response



Press **P2** on controller **A**.

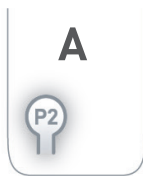

Motor Response



Press **STOP** on a new controller to add it.



Motor Response



Consult user manual for your controller or

## 8.4.2 Using a pre-existing controller to add or delete a controller or channel

**A** = Existing controller or channel (to keep)

**B** = Controller or channel to add or remove

Press **P2** on controller **A**.



Press **P2** on controller **A**.

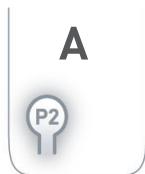

Press **P2** on the controller **B** to add or remove it.



Motor Response



Motor Response



Motor Response



Consult user manual for your controller or sensor

## 8.5 Favorite positioning

### 8.5.1 Set a favorite position

Move shade to the desired position by pressing the **UP** or **DOWN** button on the

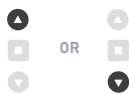

Press **P2** on



Press **STOP** on



Press **STOP** on



Motor Response



Motor Response



Motor Response



## 8.5.2 Send shade to favorite position



## 8.5.3 Delete favorite position

Press P2 on controller.



Press STOP on controller.



Press STOP on controller.



Motor Response



Motor Response



Motor Response



## 8.6 Sleep mode

If multiple motors are grouped on a single channel, Sleep Mode may be used to put all but 1 motor to sleep, allowing programming of just the one motor that remains "Awake".

### Enter Sleep Mode

Sleep mode is utilized to prevent a motor from incorrect configuration during other motor setup.

Hold **P1** button on motor head.

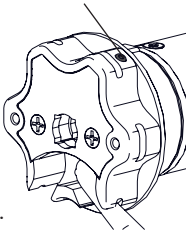

Approx.

Motor Response



### Exit Sleep Mode: Method 1

Exit sleep mode once the shade is ready.

Press and release **P1** button on the motor head

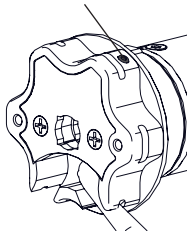

### Exit Sleep Mode: Method 2

Remove power and then re-power the motor.

## 8.7 Reset to factory settings via remote

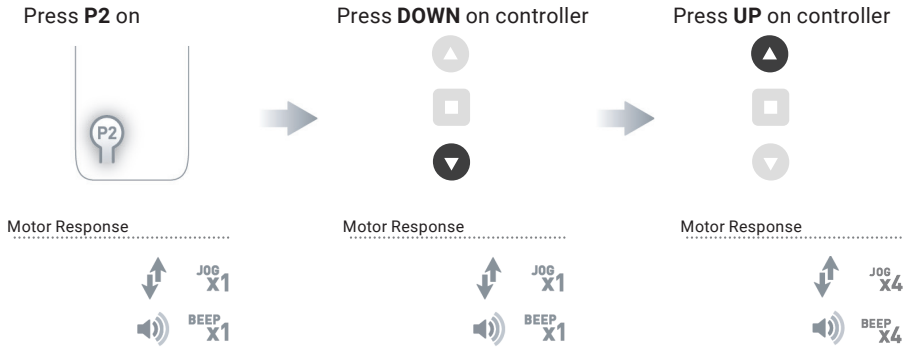

## 8.8 Sensor function

### 8.8.1 Sensor prioritize function

Once the motor receives a command from the AUTOMATE solar and wind sensor or AUTOMATE motion sensor the motor will respond accordingly. At this point the motor will ignore any other remote or sensor commands for 8 minutes. This function is needed to avoid contradicting multiple triggers. Keep this in mind when testing the motor with the remote after the wind sensor or motion sensor has been triggered. The sensor function is ON by default.

Note: Motor will jog to alert user if operated within the 8 minutes.

## 9 SUN AND WIND SENSOR

Ensure the Sun and Wind sensor functionality on the motor is activated prior to pairing the Sun and Wind sensor.

### 9.1 Activate/Deactivate Sun and Wind sensor functionality on the Motor

Note: Functionality activated by default.

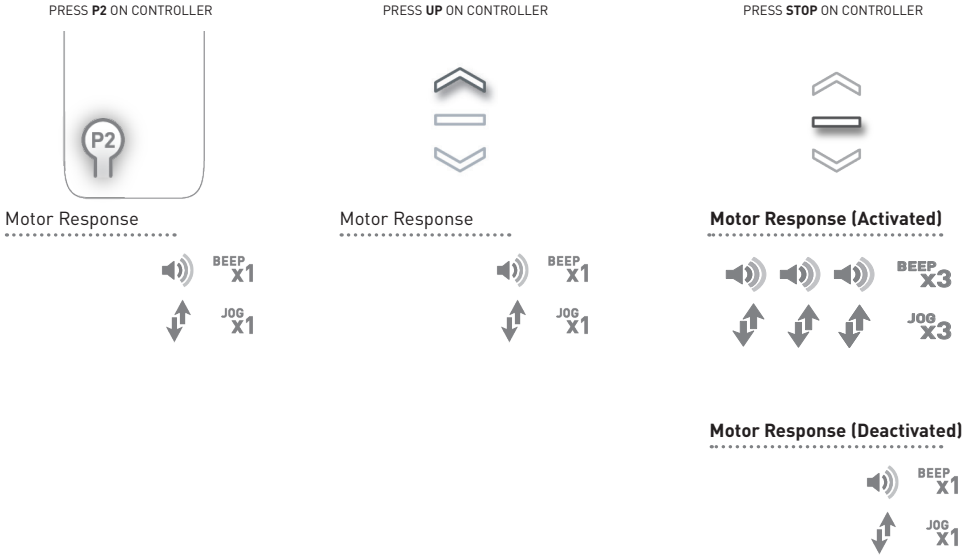

### 9.2 Pairing Sun and Wind sensor to Motor

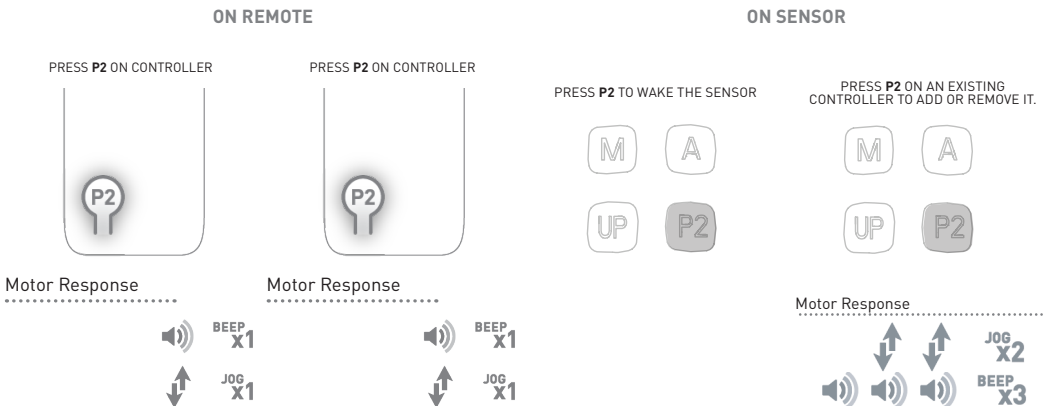



# 10 TROUBLESHOOTING

Problem	Cause	Remedy
Motor is not responding	A/C power supply not plugged in.	Check motor to power cable connection and AC plug
	Transmitter battery is discharged	Replace battery
	Radio interference/shielding	Ensure transmitter is positioned away from metal objects and the aerial on motor or receiver is kept straight and away from metal
	Receiver distance is too far from transmitter	Move transmitter to a closer position
	Power failure	Check power supply to motor is connected and active
	Incorrect wiring	Check that wiring is connected correctly (refer to motor installation instructions)
Cannot program a single Motor (multiple motors respond)	Multiple motors are paired to the same channel	Always reserve an individual channel for programming functions
		SYSTEM BEST PRACTICE - Provide an extra 15 channel controller in your multi-motor projects, that provides individual control for each motor for programming purposes
		Place all other motors into sleep mode (refer to <b>P1</b> button function overview)

A series of horizontal dotted lines for taking notes.

A series of horizontal dotted lines for taking notes.

ROLLEASE ACMEDA | USA

Level 7 / 750 East Main Street  
Stamford, CT 06902, USA

T +1 800 552 5100 | F +1 203 964 0513

ROLLEASE ACMEDA | AUSTRALIA

110 Northcorp Boulevard,  
Broadmeadows VIC 3047, AUS

T +61 3 9355 0100 | F +61 3 9355 0110

ROLLEASE ACMEDA | EUROPE

Via Conca Del Naviglio 18,  
Milan (Lombardia) Italy

T +39 02 8982 7317 | F +39 02 8982 7317