

MOTOR PROGRAMMING INSTRUCTIONS

DC Power Distribution Panel



RELIABLE, COST
EFFECTIVE POWER



LED STATUS



SECURE LOCK



DIFFERENT
WIRE TYPES



AUTOMATE | DC Power Distribution Panel provides power for up to 18 separate ARC DC motors. Higher 15V output allows for greater cable lengths from motor to power panel, freeing up routing options within an installation.

Removes the need for multiple individual power adaptors for each DC motor in an installation, combining each power source into a single location. Channels may also be wired in parallel to provide additional power to larger motors. Additional information and updates are available at <https://www.rolleseeacmeda.com>

FEATURES:

- Capacity for up to 18 ARC DC motors (25mm and 28mm motors)
- Ability to parallel connect motor supplies for higher current motors (35mm and 45mm motors)
- LED status indication for checking whether power is being applied to panel
- LED status indication for each individual motor supply

Part #: MT03-0301-411005 Automate |15V DC,24A,360W, 18CH Power 100-240VAC

CONTENTS

1	FEATURES	3
2	SAFETY INSTRUCTIONS	4
3	INSTALLATION	6
3.1	Cable Run Reference Table (Maximum Lengths)	6
3.2	Motor Power Distribution Setup	7
3.3	Wiring Diagram – Individual Connection (ZERO Head DC 25mm & 28mm)	8
3.4	Wiring Diagram – Two Wire Entry Connections in Parallel (MTDCRF45/35)	8
3.5	JST Connector Recommendations for Custom Cable Adaptors	9
3.6	Status LED Indication	10
4	SPECIFICATIONS	10
5	TROUBLESHOOTING	11
6	WIRE GAUGE DIMENSIONS	11
	APPENDIX CONTENTS	12

1 FEATURES

1. Internal power Switch
2. Mains Power supply (120V/240V)
3. 18 wire entries with clamp screws
4. IEC-C14 Connector for Mains Power Input
5. 18 Individual fuses for channel protection (Quick Blow Fuse 3.15A M205)
6. 18 Channel Status LEDs
7. Plastic Plugs (For cable routing)
8. Potentiometer for output voltage adjustment
9. Cooling fan
10. Terminal Block

Note: Keys can't be replaced if lost.

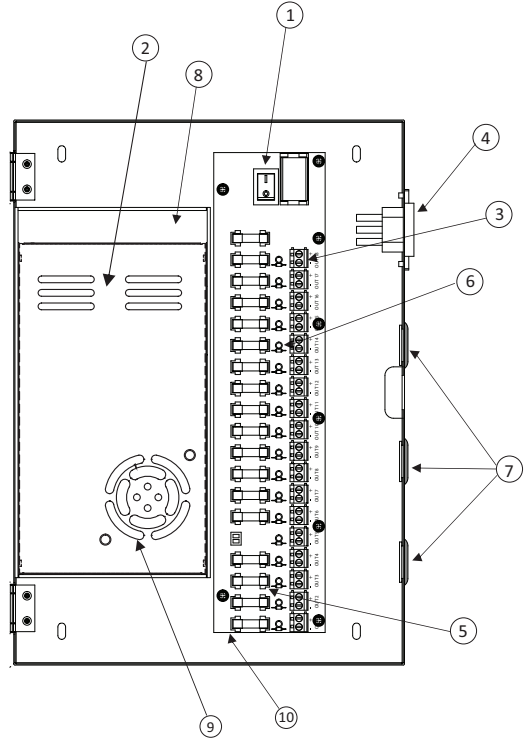

2 SAFETY INSTRUCTIONS

WARNING: Important safety instructions to be read before installation.

Incorrect installation can lead to serious injury, which may result in death and will void manufacturer's liability and warranty.

AVERTISSEMENT: Consignes de sécurité importantes à lire avant l'installation.

Une installation incorrecte peut entraîner des blessures graves, voire mortelles, et annule la responsabilité et la garantie du fabricant.

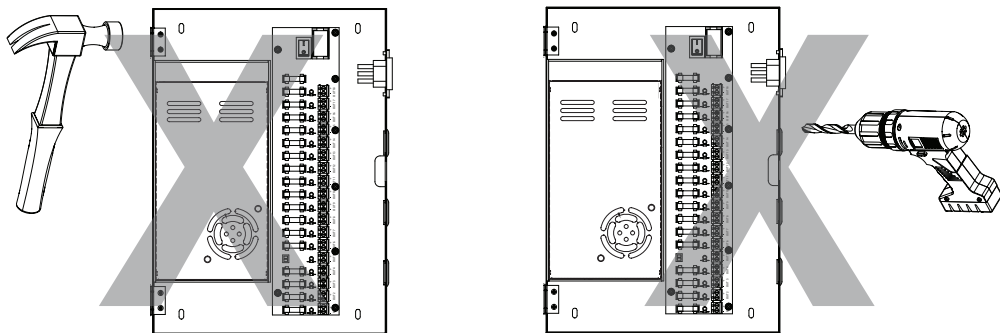

CAUTION

- Do not expose to moisture or extreme environments.
- Do not allow children to play with this device.
- Use or modification outside the scope of this instruction manual will void warranty.
- Installation and setup to be performed by a suitably qualified installer.
- For use with DC powered motorized shading devices.
- Frequently inspect for improper operation. Do not use if repair or adjustment is necessary.
- Keep clear when in operation.
- For use with DC motors only (NOT suitable for charging Li-ion Battery powered motors).
- Do not cut power cables
- Do not drill into motor body or distribution panel.
- The routing of cable through walls shall be protected by isolating bushing or grommets.
- Ensure motor power cable and aerial is clear and protected from moving parts.
- If cable or power connector is damaged do not use.

MISE EN GARDE

- Ne pas exposer à l'humidité ou à des environnements extrêmes.
- Ne laissez pas les enfants jouer avec cet appareil.
- Toute utilisation ou modification en dehors de ce manuel d'instructions annulera la garantie.
- L'installation et la configuration doivent être effectuées par un installateur qualifié.
- À utiliser avec les dispositifs d'ombrage motorisés alimentés en courant continu.
- Inspectez fréquemment l'utilisation non conforme. Ne pas utiliser si une réparation ou un réglage est nécessaire.
- Restez à l'écart lors de l'exploitation.
- À utiliser uniquement avec des moteurs à courant continu (NE convient PAS pour charger des moteurs alimentés par batterie Li-ion).
- Ne pas couper les câbles d'alimentation
- Ne percez pas dans le corps du moteur ou le panneau de distribution.
- Le passage des câbles à travers les murs doit être protégé en isolant les traversées ou les passe-câbles.
- Assurez-vous que le câble d'alimentation du moteur et l'antenne sont dégagés et protégés des pièces mobiles.
- Si le câble ou le connecteur d'alimentation est endommagé, ne l'utilisez pas.

2 SAFETY INSTRUCTIONS

Important safety instructions to be read prior to operation.

- It is important for the safety of persons to follow the enclosed instructions.
- Persons (including children) with reduced physical, sensory or mental capabilities, or lack of experience and knowledge should not be allowed to use this product.
- Frequently inspect for improper operation. Do not use if repair or adjustment is necessary.

Consignes de sécurité importantes à lire avant utilisation.

- Pour la sécurité des personnes, il est important de suivre les instructions fournies.
- Les personnes (y compris les enfants) dont les capacités physiques, sensorielles ou mentales sont réduites ou qui manquent d'expérience et de connaissances ne devraient pas être autorisées à utiliser ce produit.
- Gardez les télécommandes hors de la portée des enfants.
- Inspectez fréquemment l'utilisation non conforme. Ne pas utiliser si une réparation ou un réglage est nécessaire.

Save these instructions for future reference.

Conservez ces instructions pour référence future.



Do not dispose of in general waste.
Please recycle batteries and damaged electrical products appropriately.
Ne pas jeter avec les déchets ordinaires.
Veuillez recycler les piles et les produits électriques endommagés de manière appropriée.



3 INSTALLATION

3.1 Cable Run Reference Table (Maximum Lengths)



IMPORTANT!

MOTOR POWER CABLE RUN LENGTHS MUST NOT EXCEED THE DISTANCES IN THE REFERENCE TABLE BELOW WHEN VOLTAGE HAS BEEN REDUCED FOR USE WITH AUTOMATE PULSE 2 HUB AND APPLICATION.

Failure to do so will result in loss of voltage along the cable run, subsequently resulting in insufficient voltage at the motor input terminals.

Before connection of any motors to the power distribution panel, check cable lengths and wire gauge (AWG), against this table in order to ensure system will operate to specification.

	ROLLEASE ACMEDA MOTORS					
	MT01-1225-069002 MT01-1225-069004	MT01-1228-069002 MT01-1228-069003	MTDCRF35-3 MTDCRFQ45-3 MTDCRF45-10	MTDCRF-CL-0.6-50	MT01-3001-069001	MTDCRF-TILT-1
	14V	14V	12V	12V	14V	12V
≤15m	24 AWG	24 AWG	22 AWG	20 AWG	20 AWG	18 AWG
20m	24 AWG	24 AWG	20 AWG	20 AWG	20 AWG	18 AWG
25m	24 AWG	22 AWG	20 AWG	20 AWG	20 AWG	18 AWG
30m	24 AWG	22 AWG	18 AWG	20 AWG	20 AWG	18 AWG
35m	22 AWG	20 AWG	18 AWG	20 AWG	20 AWG	18 AWG
40m	22 AWG	20 AWG	18 AWG	20 AWG	20 AWG	18 AWG
45m	22 AWG	20 AWG	18 AWG	20 AWG	20 AWG	18 AWG
50m - 60m	20 AWG	18 AWG	16 AWG	20 AWG	20 AWG	16 AWG
65m	20 AWG	18 AWG	16 AWG	18 AWG	20 AWG	16 AWG
70m	20 AWG	18 AWG	16 AWG	18 AWG	20 AWG	16 AWG
75m	20 AWG	18 AWG	N/A	18 AWG	20 AWG	N/A
80m	18 AWG	16 AWG	N/A	18 AWG	18 AWG	N/A
85m	18 AWG	16 AWG	N/A	18 AWG	18 AWG	N/A
90m	18 AWG	16 AWG	N/A	18 AWG	18 AWG	N/A
95m	18 AWG	16 AWG	N/A	18 AWG	18 AWG	N/A
100m	18 AWG	16 AWG	N/A	16 AWG	18 AWG	N/A
105m	18 AWG	16 AWG	N/A	16 AWG	18 AWG	N/A
110m	18 AWG	16 AWG	N/A	16 AWG	18 AWG	N/A
115m	18 AWG	16 AWG	N/A	16 AWG	18 AWG	N/A
120m - 160m	16 AWG	N/A	N/A	16 AWG	16 AWG	N/A
165m	16 AWG	N/A	N/A	N/A	16 AWG	N/A
170m	16 AWG	N/A	N/A	N/A	16 AWG	N/A
175m	16 AWG	N/A	N/A	N/A	16 AWG	N/A
180m	16 AWG	N/A	N/A	N/A	16 AWG	N/A
185m - 210m	N/A	N/A	N/A	N/A	16 AWG	N/A
215m	N/A	N/A	N/A	N/A	N/A	N/A

*Refer to section 6 on page 11 for detailed American Wire Gauge (AWG) dimensions

3.2 Motor Power Distribution Setup

OVERVIEW

- One wire entry is connected to one of ZERO Head DC 25mm & 28mm motors.
- Two wire entries are connected to one of MTDCRF45/35 motors.
- All motor connections must be made before power applies to the distribution panel.
- Use of two parallel connections ensures the power supply is not overloaded during larger motor operation.

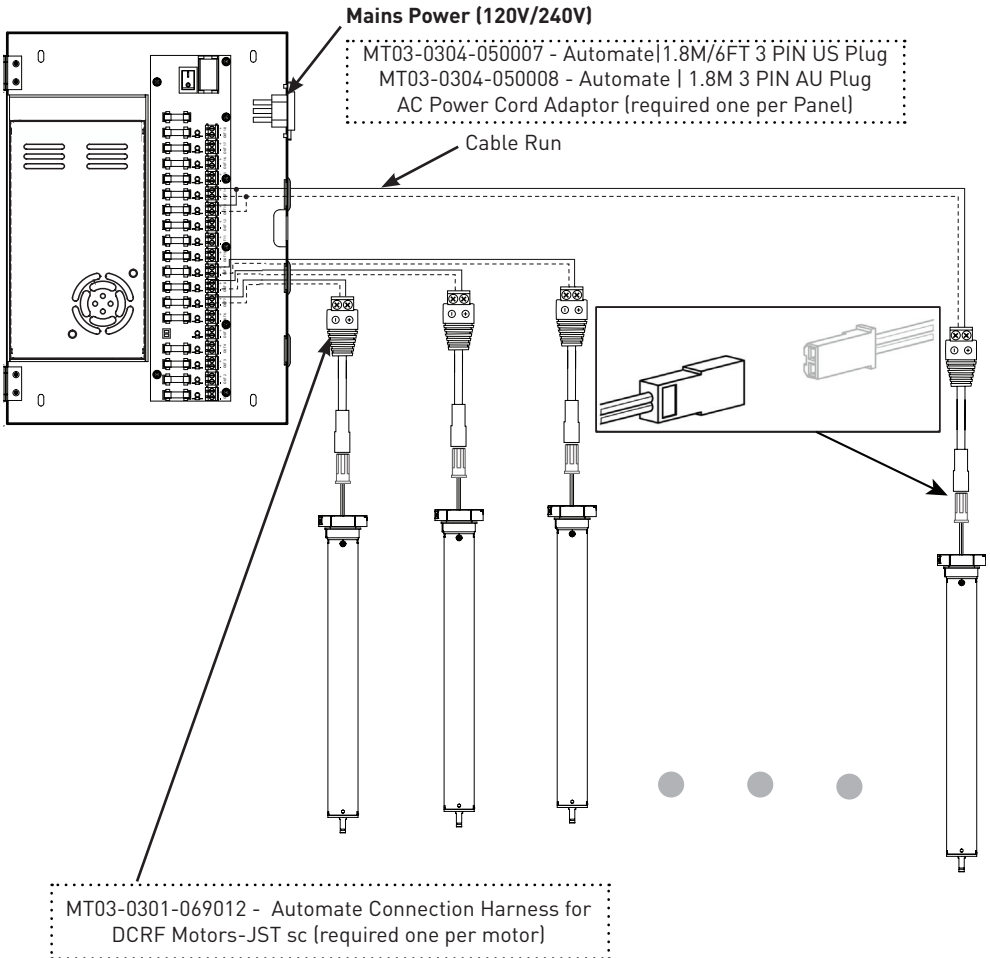

3.3 Wiring Diagram – Individual Connection (ZERO Head DC 25mm & 28mm)

Low power motors may be connected individually to one wire entry of the terminal block, with care being taken to ensure polarity is correct (see page 4). Incorrect polarity will stop the motor from functioning.

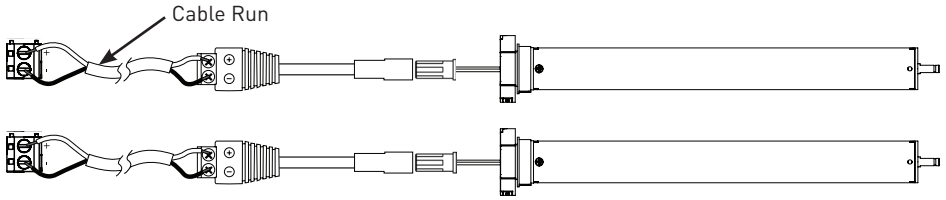

This connection may only be used when wiring 28mm & 25mm motors to the distribution panel, as these motors do not exceed the 1.33 A current limit per channel.

3.4 Wiring Diagram – Two Wire Entry Connections in Parallel (MTDCRF45/35)



IMPORTANT!

WARNING: Important instructions to read before commencing wiring of 45mm and 35mm motors.

Due to higher power demands, these motors must be wired in a parallel configuration (shown below) utilizing two wire entries in order to avoid overloading the power circuit and blow the protection fuses.

AVERTISSEMENT: Les instructions importantes à lire avant de commencer le câblage de 45mm et Moteurs 35mm.

En raison de demandes de puissance plus élevées, ces moteurs doivent être câblés dans une configuration parallèle (illustrée ci-dessous) en utilisant deux canaux afin d'éviter de surcharger le circuit d'alimentation et d'endommager le tableau de distribution.

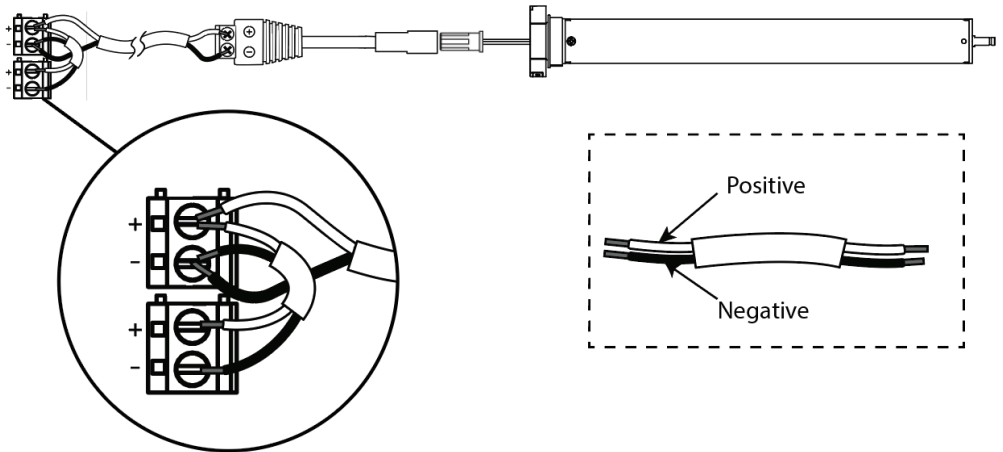

Due to 1.33A limit per channel, working current can be doubled to 2.66A with parallel configuration as shown above, allowing connection of 45mm and 35mm motors.

En raison de la limite de 1,33 A par canal, le courant de travail peut être doublé à 2,66 A avec une configuration en parallèle, comme indiqué ci-dessus, permettant la connexion de moteurs de 45 mm et 35 mm.

CAUTION: Before plugging in this equipment to mains power;

- Ensure the internal power switch (1) (page 2) is in the OFF position.
- Check the mains input (2) (page 2) DC output for any loose wires, ensuring the plastic safety covers are covering the main power supply.
- Check motor connection terminal blocks (10) (page 2) for loose wires, as well as polarity check each connection (See below)

ATTENTION: Avant de brancher cet équipement sur le secteur;

- Assurez-vous que l'interrupteur d'alimentation interne (1) (page 2) est en position OFF.
- Vérifiez que l'entrée secteur (2) (page 2) ne comporte pas de fils desserrés à la sortie CC, en veillant à ce que les capots de protection en plastique soient en place, couvrant les borniers.
- Vérifiez que les borniers de connexion du moteur (10) (page 2) ne présentent pas de fils desserrés, ainsi que la polarité. connexion (voir ci-dessous)

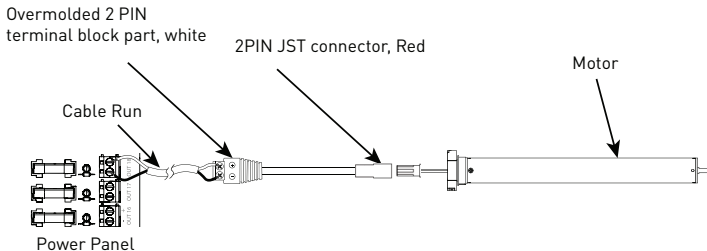

PART #: MT03-0301-069012

DESCRIPTION: Automate Connection Harness for DCRF Motors - JST to Screw connectors

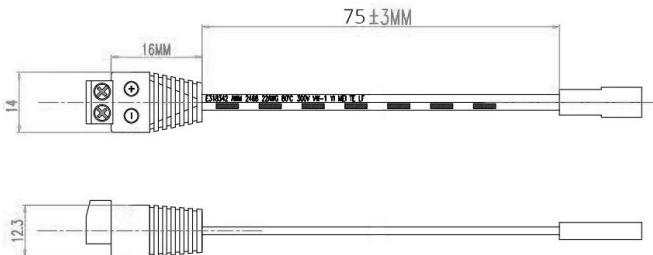

WIRING POLARITY FROM PANEL TO MOTOR

Female (Power Output)	Grey Dashes (Positive)
Male (Motor Input)	Solid White (Positive)

3.5 JST Connector Recommendations for Custom Cable Adaptors

Rollase Acmeda recommends the following JST connectors for DC power connections:

RECOMMENDED JST CONNECTORS			
DESCRIPTION	PART NO.	MANUFACTURER	Digikey.com PART NO.
Male Connector (White)	SYR-02TV	JST SALES AMERICA INC.	455-2655-ND
Male Connector (Red)	SYR-02T	JST SALES AMERICA INC.	455-2653-ND
Male Pin Contact	SYM-001T-P0.6(N)	JST SALES AMERICA INC.	455-1909-1-ND

3.6 Status LED Indication



IMPORTANT!

Status LEDs for each motor channel indicate the condition of the inline fuse. If the status LED is not lit up when power is supplied to the panel, then the inline fuse for that channel has blown.

Disconnect all power to the Panel and inspect the individual motor and supply cable to the motor in order to determine why the fault occurred.

Once the fault has been determined, make the appropriate repairs and replace the fuse with a 3.15A M205 quick blow fuse.

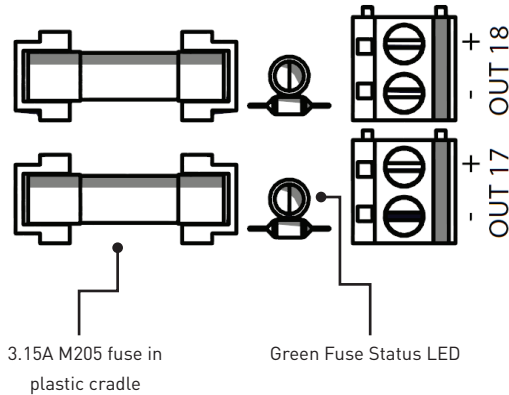

3.15A M205 fuse in plastic cradle

Green Fuse Status LED

In order to replace fuse, carefully pry the fuse out of the plastic cradle using a small tool (such as a small screwdriver or pen). To replace, gently press the new fuse into the cradle.

To test LED, apply power to the distribution panel, and observe whether the channel LED is glowing.

4 SPECIFICATIONS

TECHNICAL SPECIFICATIONS	
PARAMETERS	VALUE
Input Voltage Range	100 VAC - 240 VAC
Output Voltage Range	11.4 - 15 VDC
Maximum Output Current (all 18 channels)	24 A
Power Output Rating	360 W
Single Channel Absolute Maximum Current Output	1.33 A
Ingress Protection	IP20

5 TROUBLESHOOTING



IMPORTANT!

WARNING: Distribution panel is connected to (120V/240V) mains power. Do not attempt to troubleshoot panel without first disconnecting all power and waiting a period of 5 minutes.

AVERTISSEMENT: le panneau de distribution est connecté au secteur (120V / 240V). Ne pas tenter dépanner le panneau sans d'abord couper l'alimentation et attendre un certain temps de 5 minutes.

PROBLEM	CAUSE	REMEDY
No Motors are responding	A/C power supply not plugged in	Check exterior LED Check Panel to power connection and IEC connector and AC plug
	Internal power switch turned off	Power is supplied to panel, but exterior LED is not lit. Open panel and switch internal power switch to ON position
	A/C terminal block wiring is incorrect	CAUTION: Do NOT attempt to rewire mains power terminal block. Only to be performed by a suitably qualified installer
Individual Motor is not responding	Motor channel fuse has blown	Check individual LED's Replace fuse as necessary (refer to section 1.5)
	Motor wiring is incorrect	Refer to wiring diagram on page 6
	Motor is in sleep mode	Refer to motor's programming instructions in order to change motor sleep status

6 WIRE GAUGE DIMENSIONS

AMERICAN WIRE GAUGE DIMENSIONS		
WIRE GAUGE	DIAMETER	CROSS-SECTIONAL AREA
24 AWG	0.51054 mm (0.0201 in)	0.205 mm ² (0.00032 in ²)
22 AWG	0.64516 mm (0.0254 in)	0.326 mm ² (0.00051 in ²)
20 AWG	0.8128 mm (0.032 in)	0.518 mm ² (0.00080 in ²)
18 AWG	1.02362 mm (0.0403 in)	0.823 mm ² (0.00128 in ²)
16 AWG	1.29032 mm (0.0508 in)	1.31 mm ² (0.00203 in ²)

APPENDIX CONTENTS

A	APPENDIX 1 DC POWER DIST. PANEL + PULSE 2.0 HUB & APP.	12
A.1	PULSE 2.0 HUB - ADDITIONAL INSTALLATION/SET UP INSTRUCTIONS	13
A.2	ADJUSTMENT PROCEDURE	13
A.3	TROUBLE SHOOTING	14
A.4	NOTES	15

A APPENDIX 1 | DC POWER DIST. PANEL + PULSE 2.0 HUB & APP.



A.1 PULSE 2.0 HUB - ADDITIONAL INSTALLATION/SET UP INSTRUCTIONS



IMPORTANT!

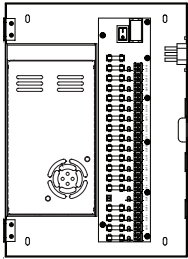

If motors powered by the DC Power Distribution Panel are to be used with the **Automate Pulse 2 Hub and Application**, the output voltage of the Distribution Panel **MUST** be adjusted to allow for proper communication between the Hub and Motor.

Output Voltage (11.4VDC to 15VDC) of the DC Power Distribution Panel can be adjusted via the Trim-Pot located on the converter within the Distribution Panel.

NOTE: Adjusted Output voltage is applicable to all 18 Channels.



IMPORTANT!

If motors are connected to the Automate Pulse 2 Hub, it is **RECOMMENDED** the motors of the same type (ZERO Head DC 25mm & 28mm or MTDCRF45/35) are used in the installation. It is **NOT** recommended to power motors of differing types from one DC Power Distribution Panel.

A.2 ADJUSTMENT PROCEDURE



IMPORTANT!

WARNING: DANGEROUS LIVE VOLTAGE.
DO NOT ATTEMPT UNLESS QUALIFIED TO OPERATE AC MAINS VOLTAGE DEVICES.

Output Voltage of the Distribution Panel must be monitored as it is adjusted. This involves probing the output of the Panel while it is live.

Monitor output voltage using a **multimeter**, and adjust potentiometer using an appropriately sized Philips Head screwdriver.

When motors are to be controlled via the Automate Pulse 2 Hub, the maximum allowable voltages for each motor is as shown:

	MOTOR
12V	MTDCRF35-3
	MTDCRFQ45-3
	MTDCRF45-10
	MTDCRF-CL-0.6-50
	MTDCRF-TILT-1
14V	MT01-1225-069002
	MT01-1225-069004
	MT01-3001-069001

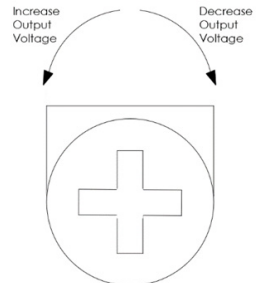

A.3 TROUBLE SHOOTING



IMPORTANT!

WARNING: Distribution panel is connected to (120V/240V) mains power. Do not attempt to troubleshoot panel without first disconnecting all power and waiting a period of 5 minutes.

AVERTISSEMENT: le panneau de distribution est connecté au secteur (120V / 240V). Ne pas tenter dépanner le panneau sans d'abord couper l'alimentation et attendre un certain temps de 5 minutes.

PROBLEM	CAUSE	REMEDY
Motor is not responding to the App/ updating App animation and motor position	Panel Output Voltage is too low	Adjust Trim-Pot to increase output voltage
Motor showing as offline	Voltage at motor terminal is too high/too low	Adjust Trim-Pot to decrease/increase the output voltage

A.4 NOTES

ROLLEASE ACMEDA | USA

Level 7 / 750 East Main Street
Stamford, CT 06902, USA

T +1 800 552 5100 | F +1 203 964 0513

ROLLEASE ACMEDA | AUSTRALIA

110 Northcorp Boulevard,
Broadmeadows VIC 3047, AUS

T +61 3 9355 0100 | F +61 3 9355 0110

ROLLEASE ACMEDA | EUROPE

Via Conca Del Naviglio 18,
Milan (Lombardia) Italy

T +39 02 8982 7317 | F +39 02 8982 7317