



Push 5

Programming Guide

MT02-0101-xxx004_v2.2_08032024

SAFETY

▲ WARNING: Important safety instructions to be read before installation and use.

Incorrect installation or use can lead to serious injury and will void manufacturer's liability and warranty. It is important for the safety of persons to follow the enclosed instructions. **Save these instructions for future reference.**

Do not expose to water, moisture, humid and damp environments or extreme temperatures.

Persons (including children) with reduced physical, sensory or mental capabilities, or lack of experience and knowledge, should not be allowed to use this product.

Use or modification outside the scope of this instruction manual will void warranty.

Installation and programming to be performed by a suitably qualified installer.

Follow installation instructions.

For use with motorized shading devices.

Frequently inspect for improper operation.

Do not use if repair or adjustment is necessary.

Keep clear when in operation.

Replace battery with correctly specified type.



Remove and immediately recycle or dispose of used batteries according to local regulations and keep away from children. Do NOT dispose of batteries in household trash or incinerate.

Even used batteries may cause severe injury or death.

Call a local poison control center for treatment information.

Non-rechargeable batteries are not to be recharged.

Do not force discharge, recharge, disassemble, heat above (manufacturer's specified temperature rating) or incinerate. Doing so may result in injury due to venting, leakage or explosion resulting in chemical burns.

Ensure the batteries are installed correctly according to polarity (+ and -).

Do not mix old and new batteries, different brands or types of batteries, such as alkaline, carbon-zinc, or rechargeable batteries. Remove and immediately recycle or dispose of batteries from equipment not used for an extended period of time according to local regulations.

Always completely secure the battery compartment. If the battery compartment does not close securely, stop using the product, remove the batteries, and keep them away from children.

▲ WARNING

INGESTION HAZARD: This product contains a button cell or coin battery. DEATH or serious injury can occur if ingested. A swallowed button cell or coin battery can cause Internal Chemical Burns in as little as 2 hours. KEEP new and used batteries OUT OF REACH OF CHILDREN. Seek immediate medical attention if a battery is suspected to be swallowed or inserted inside any part of the body.

FCC & ICED STATEMENT

FCC ID: 2AGGZMT0201014
IC: 21769-MT0201014

Operation Temperature Range: -10°C to +50°C
Ratings: 3VDC, 15mA

This device complies with part 15 of the FCC Rules. Operation is subject to the following two conditions:
(1) This device may not cause harmful interference, and
(2) this device must accept any interference received, including interference that may cause undesired operation.

Caution: Changes or modifications to this unit not expressly approved by the party responsible for compliance could void the user's authority to operate the equipment.

This device contains licence-exempt transmitter(s)/receiver(s) that comply with Innovation, Science and Economic Development Canada's licence-exempt RSS(s). Operation is subject to the following two conditions:

- (1) This device may not cause interference.
- (2) This device must accept any interference, including interference that may cause undesired operation of the device.

L'émetteur/récepteur exempt de licence contenu dans le présent appareil est conforme aux CNR d'Innovation, Sciences et Développement économique Canada applicables aux appareils radio exempts de licence. L'exploitation est autorisée aux deux conditions suivantes :

- 1) L'appareil ne doit pas produire de brouillage;
- 2) L'appareil doit accepter tout brouillage radioélectrique subi, même si le brouillage est susceptible d'en compromettre le fonctionnement.

NOTE: This equipment has been tested and found to comply with the limits for a Class B digital device, pursuant to part 15 of the FCC Rules. These limits are designed to provide reasonable protection against harmful interference in a residential installation. This equipment generates, uses and can radiate radio frequency energy and, if not installed and used in accordance with the instructions, may cause harmful interference to radio communications. However, there is no guarantee that interference will not occur in a particular installation. If this equipment does cause harmful interference to radio or television reception, which can be determined by turning the equipment off and on, the user is encouraged to try to correct the interference by one or more of the following measures:

- Reorient or relocate the receiving antenna.
- Increase the separation between the equipment and receiver.
- Connect the equipment into an outlet on a circuit different from that to which the receiver is connected.
- Consult the dealer or an experienced radio/TV technician for help.

1. ASSEMBLY

Please refer to separate Rollease Acmeda System Assembly Manual for full assembly instructions relevant to the hardware system being used.

2. BATTERY MANAGEMENT

For battery motors:
Prevent discharging the battery completely for extended periods, recharge as soon as the battery is discharged.

CHARGING NOTES

Charge your motor for 6-8 hours, depending on the motor model, as per motor instructions.

⚠ During operation, if battery is low, the motor will beep 10 times to prompt the user it needs charging.

P1 LOCATIONS

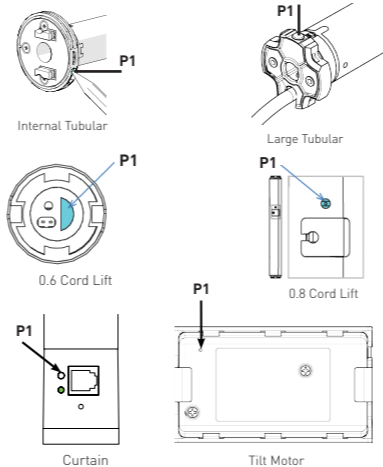

BUTTON OVERVIEW

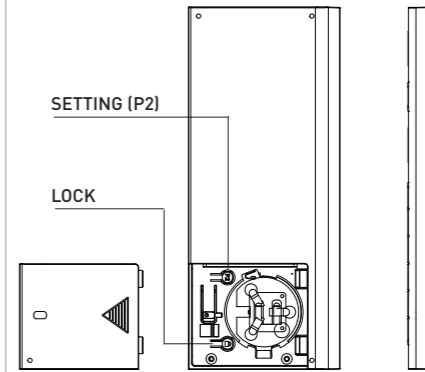
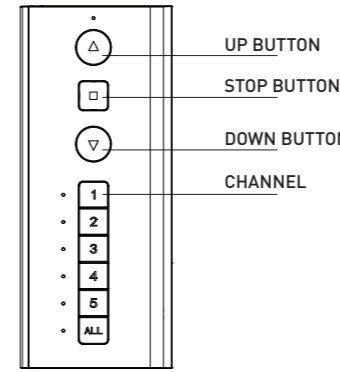

WALL MOUNTING

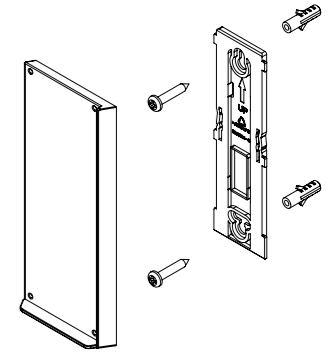

Use supplied fasteners and anchors to attach the base to wall.

HOW TO CHARGE LI-ION ZERO WIRE-FREE MOTOR



STEP 1
Rotate cover cap to expose motor head.

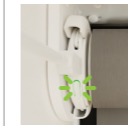

STEP 2
Find nearest power source and plug in charger (use an extension cord if required).



STEP 3
Plug micro USB end into the motor.
- Observe the green light flashing and charge until the green light goes solid green.
- Please note this may take up to eight hours depending on how flat your battery is.
- Any mobile phone charger can also be used to charge your motor.

STEP 4
Unplug and return cover cap to conceal motor head.

REPLACE BATTERY

STEP 1
Use a tool (such as a SIM card pin, mini screwdriver, etc.) to push the battery cover release button and simultaneously slide the battery cover in the direction shown.

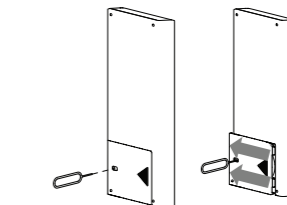

STEP 2
Install CR2450 Battery with positive (+) side facing up.

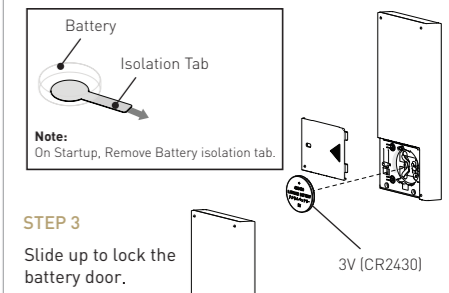

STEP 3
Slide up to lock the battery door.

INSTALLER

This setup wizard should be used for new installation or factory reset motors only. Individual steps may not work if you haven't followed the setup from the beginning.

INSTALLER

ON REMOTE

STEP 1.

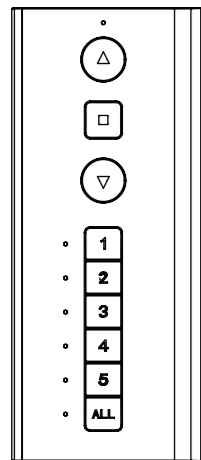

Select a single or multiple channels by toggling channels as required. Note the corresponding LED next to each channel.

STEP 2.

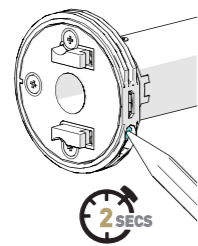

* Internal Tubular Motor pictured. Refer to "P1 Locations" for specific devices.

Press the P1 button on the motor for 2 Seconds until the motor responds as below.

MOTOR RESPONSE

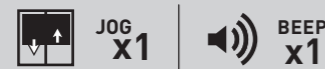

Within 4 seconds hold the stop button on the remote for 3 seconds. The motor will respond with Jog and Beep.

MOTOR RESPONSE

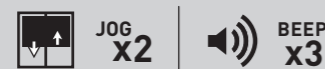

CHECK DIRECTION

STEP 3.

Press up or down to check the motor direction. If correct skip to step 5.

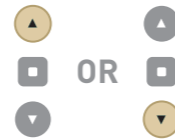

CHANGE DIRECTION

STEP 4.

If the shade direction needs to be reversed; press and hold the up & down arrow together for 5 seconds until the motor Jogs.

MOTOR RESPONSE



Reversing motor direction using this method is only possible during initial set-up.

SET TOP LIMIT

STEP 5.

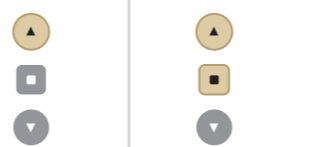

Move shade to desired top limit by pressing the up arrow repeatedly. Then press and hold up & stop together for 5 sec to save limit.

Tap the arrow several times or hold down if needed; press arrow to stop.

MOTOR RESPONSE



SET BOTTOM LIMIT

STEP 6.

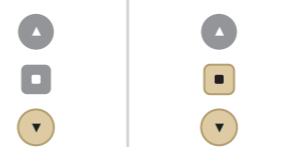

Move shade to desired bottom limit by pressing the down arrow repeatedly. Then press and hold down & stop together for 5 sec to save limit.

Tap the arrow several times or hold down if needed; press arrow to stop.

MOTOR RESPONSE



MOTOR RESET PROCEDURE FACTORY RESET

To reset all settings in the motor press and hold the P1 Button for 14 seconds, you should see 4 independent jogs followed by 4x Beeps at the end.

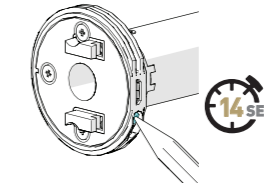

* Internal Tubular Motor pictured above. Refer to "P1 Locations" for specific devices.

MOTOR RESPONSE

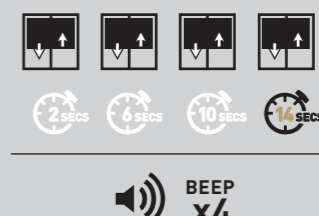

SAVE YOUR LIMIT

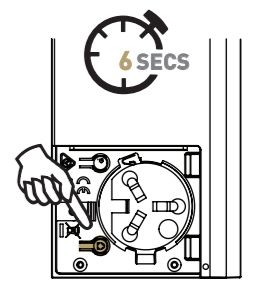

Repeat steps 1-6 for all motors. Once complete Press and hold the Lock button for 6 seconds while looking at the LED, and hold until solid.

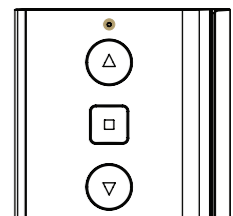

CHANNEL SELECTION

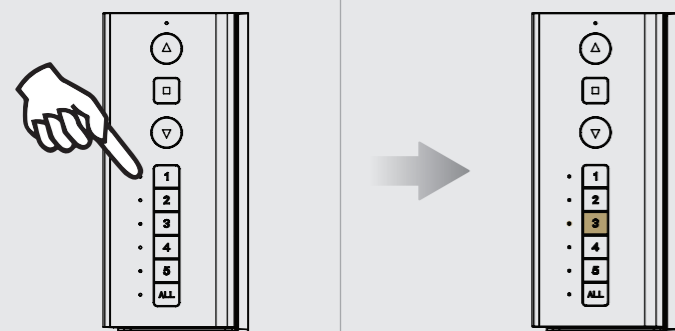

Press any channel to see previously selected channels. The last selected channel will remain in memory. To un-select a channel press the same channel and select any new channels.

CONTROLLING A SHADE

CONTROL SHADE UP OR DOWN

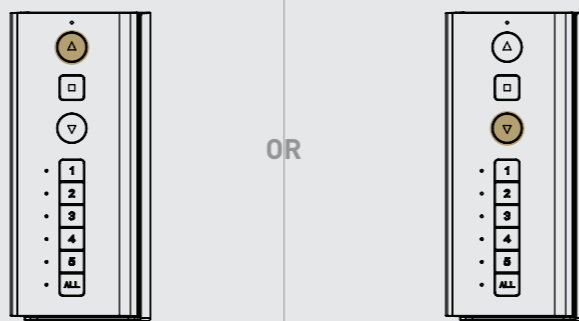

While the channel is displayed press **up or down** to move shade accordingly.

STOPPING THE SHADE

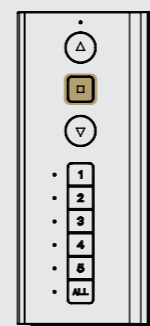

Press the stop button to stop shade at any point.

GROUP CONTROL

Channel "ALL" is pre-set to control ALL shades paired to your Multi-channel remote.

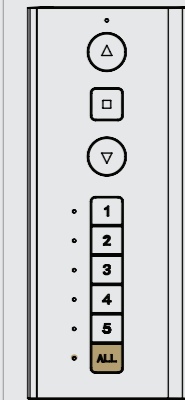

CREATE CUSTOM GROUPS

It is possible to copy one channel to another channel to create custom groups.

STEP 1.

EXISTING REMOTE

Select the channel you want to transfer.

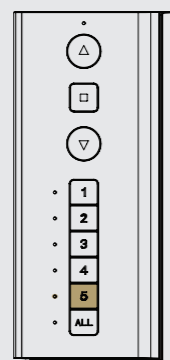

STEP 2.

Press P2 Button on existing remote.

MOTOR RESPONSE

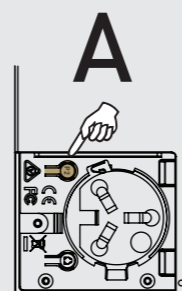

STEP 3.

Press P2 Button again on existing remote.

MOTOR RESPONSE

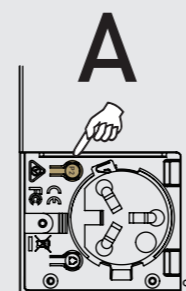
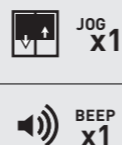

STEP 4.

(This step to be completed within four seconds of the previous step).

NEW REMOTE

Select the channel you want to transfer too.

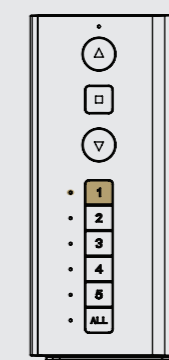

STEP 5.

Press P2 Button again on existing remote.

MOTOR RESPONSE

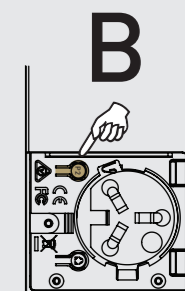

DISABLE LIMIT SETTING - LOCK BUTTON

Note: Ensure all shade programming for all motors is completed before locking the remote.

This mode is intended to be used after all shade programming is completed. User Mode will prevent accidental or unintended changing of limits.

LOCK REMOTE

Pressing the lock button for **6 second** will Lock the remote and LED will show solid.

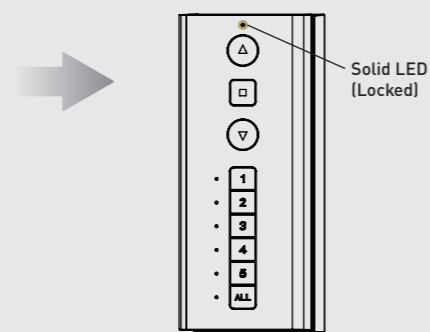
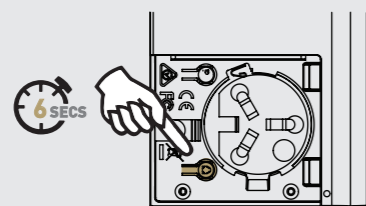

UNLOCK REMOTE

Pressing the lock button for **6 second** will Unlock the remote and LED will show flashing.

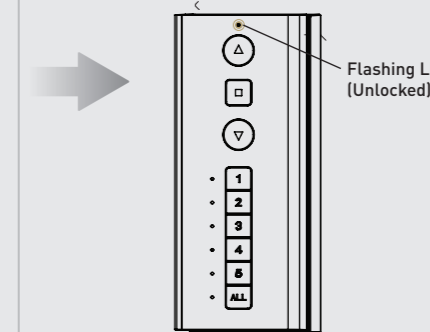
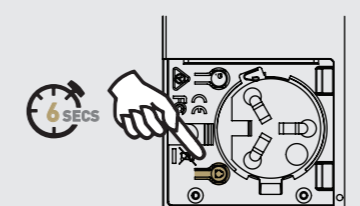

SET A FAVORITE POSITION

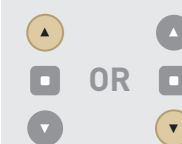

Move shade to desired position by pressing UP or DOWN on the remote.

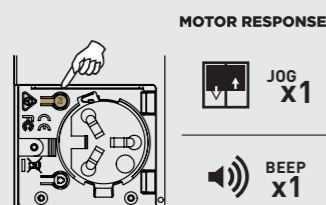

Press P2 on remote.

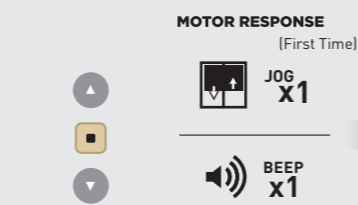

Press STOP on remote.

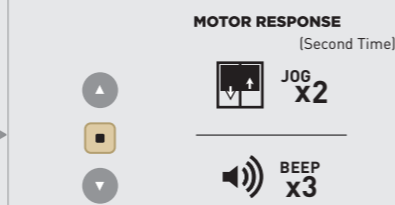

Press STOP on remote.

DELETE FAVOURITE POSITION

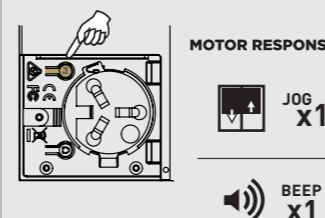

Press P2 on remote.

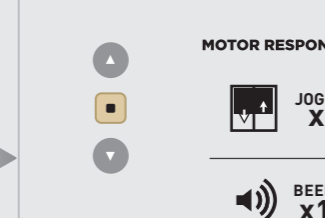

Press STOP on remote.

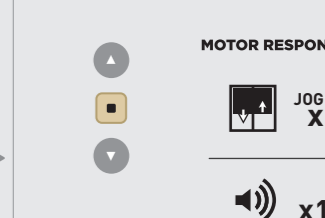

Press STOP on remote.