

AUTOMATE™

QUICK START GUIDE Automate™ Crestron Home INTEGRATION SUPPORT

AUTOMATE PULSE HUB 2 OVERVIEW:

Take your Automate experience to the next level by integrating Automate motorized shades into Crestron Home Integration systems. The Automate Pulse is a rich integration supports discrete shade control and features a two-way communication system with the Pulse 2 App that offering real time shade position and battery level status. The Automate Pulse Hub 2 supports Ethernet Cable (CAT 5) and Wireless Communication 2.4GHz) for home automate integration using the RJ45 port conveniently located on the back of the hub. Each hub can support integration of up to 30 shades.

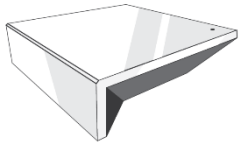

OVERVIEW:

The Pulse 2 driver provides Total Control users with two-way control of their shades, using a two-way IP driver control status feedback of Pulse 2 hubs and connected shades which is in the Crestron Home database. Before integrating Pulse 2 shades into the Crestron System, users must first configure their Pulse 2 Hub and shades. This process is done entirely in the Pulse 2 Android or iOS app.

CRESTRON HOME COMPATIBILITY:

The Crestron Home with Automate Pulse 2 two-way module is compatible with Accelerator 3 and Flex 2 software platforms.

REQUIREMENTS:

An installed and functional Pulse 2 shade system using:

- An Automate Pulse 2 Hub is configured and functioning properly.
- Windows shades installed and configured with the Pulse 2 Hub.

HARDWARE INSTALLATION:

- Install all shades/blinds/motors at desired locations.
- Connect the Hub to the Automate Pulse app on the same network as the Crestron Home System.
- Connect all shades/blinds/motors to the Automate Pulse 2 app.

MODULE FEATURES:

- Two-way control of shades
- Custom macro integration
- Queries
- Device Events
- All Shades supported by Pulse 2 Hub.
- Auto discovery process

DRIVER

- Initial Release
- This release note is for the Rollease Automate Pulse 2 Gateway IP Crestron Home driver.
- Notes and Recommendations
- This driver is compatible on Crestron Home processors using Crestron Home v3.007.0166.
- System Requirements and Dependencies
- Minimum version requirements:

4-SERIES:

- Processor firmware 2.4508.00085
- Crestron Home v3.007.0166
- Crestron Home SDK 8.0000.0012

WORKS WITH:

- CP4-R
- MC4-R

INSTALATION INSTRUCTIONS:

AUTOMATE™

A DIVISION OF
**ROLLEASE
ACMEDA**

rolleaseacmeda.com
© 2021 Rollease Acmeda Group

Follow the steps below to load and configure the driver.

1. Open the Crestron Home Setup App (either mobile version or desktop version) and connect to the Crestron Home control processor.

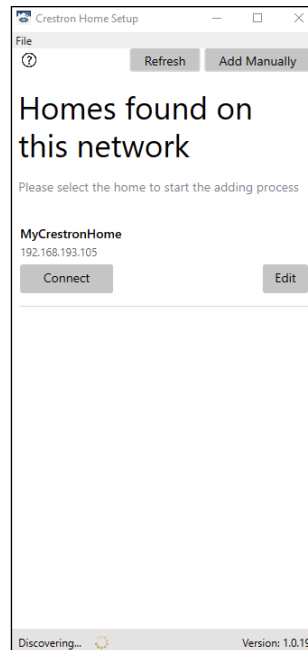

Figure 1: Connect to the Crestron Home processor.

2. When the setup app opens, press **Continue** on the main screen and log in with the Crestron Home administrator credentials.

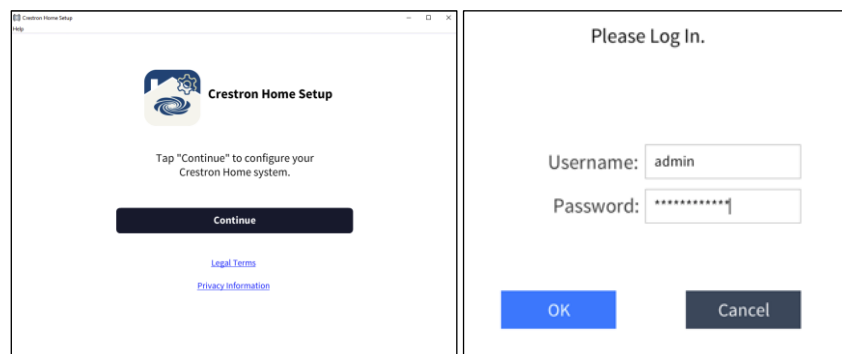

Figure 2: Log in into the Crestron Home System

AUTOMATE™

Once logged in, the Setup page will be displayed.

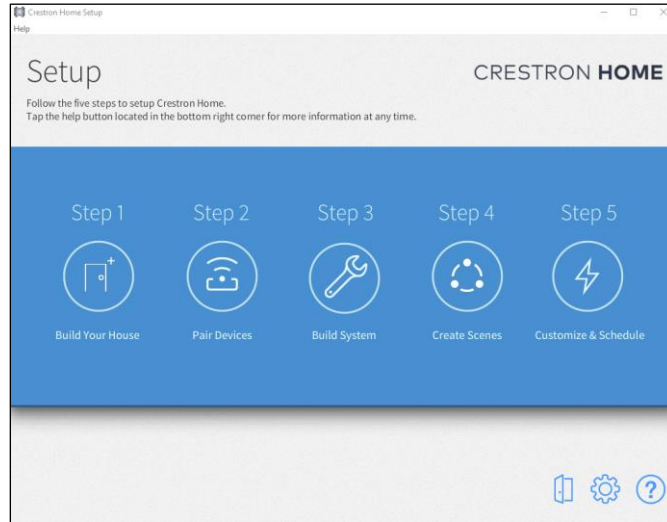

Figure 3: Start the setup process following the steps on the Crestron Home System

3. If setting up Crestron Home for the first time, press on **Build Your House** to add rooms to your configuration, otherwise skip to step 5 below.

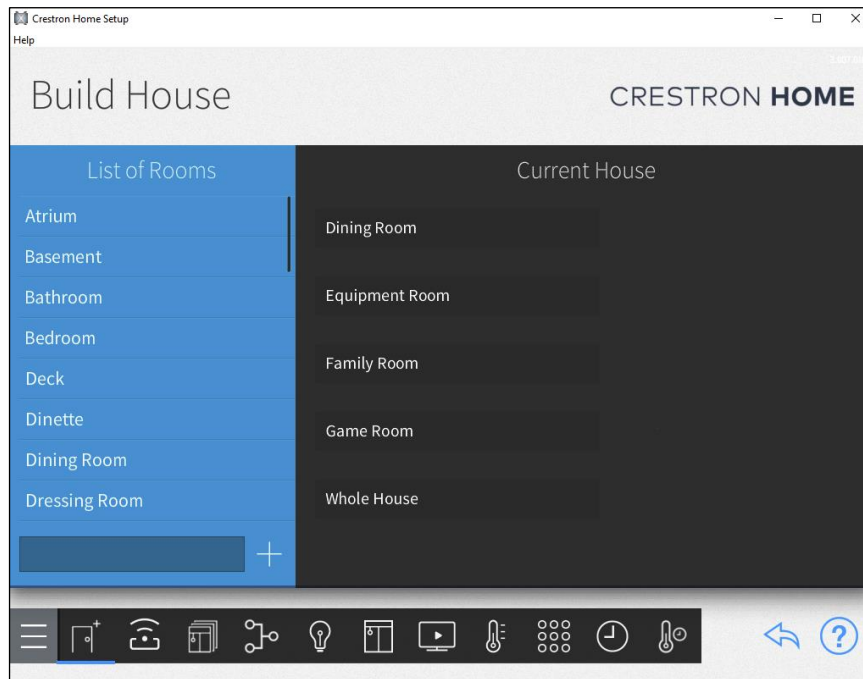

Figure 4: Build your Home if this is your first configuration.

4. Scroll through the list of available rooms and press the **Plus Sign (+)** to add the room to your configuration. A custom room name can be added by typing in the name field next to the **Plus Sign**.



5. From the Setup page, press **Pair Devices** or press the Pair Devices Icon



Figure 5: Pair New Devices (Pulse 2 Hub) with Crestron Home.

6. Follow the instructions in steps 6-13 if adding a driver for the first time, otherwise skip to step 14. In the **Pair Devices** screen, select the room to which the driver will be added from the right side of the screen, then select **Drivers** from the menu options on the left side of the screen.
7. Scroll to the driver type, press the **Platform** driver type name.
8. Scroll to the **Automate** make (manufacturer).



9. Press the **Plus Sign (+)** to add the gateway client to the project.
10. Enter the friendly name for the driver and the IP address to connect to.

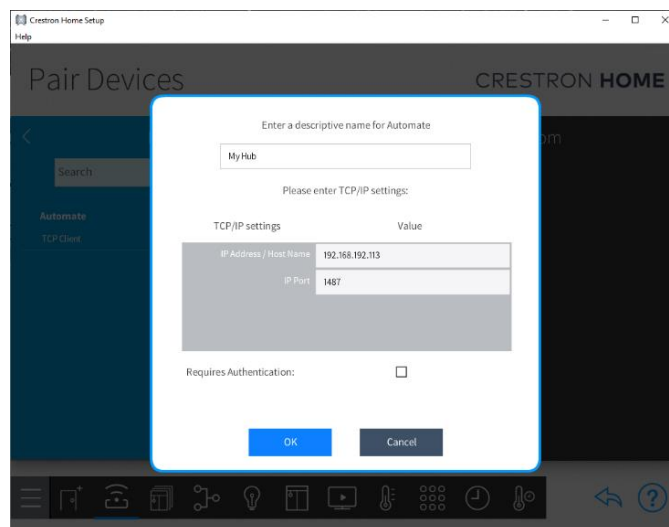
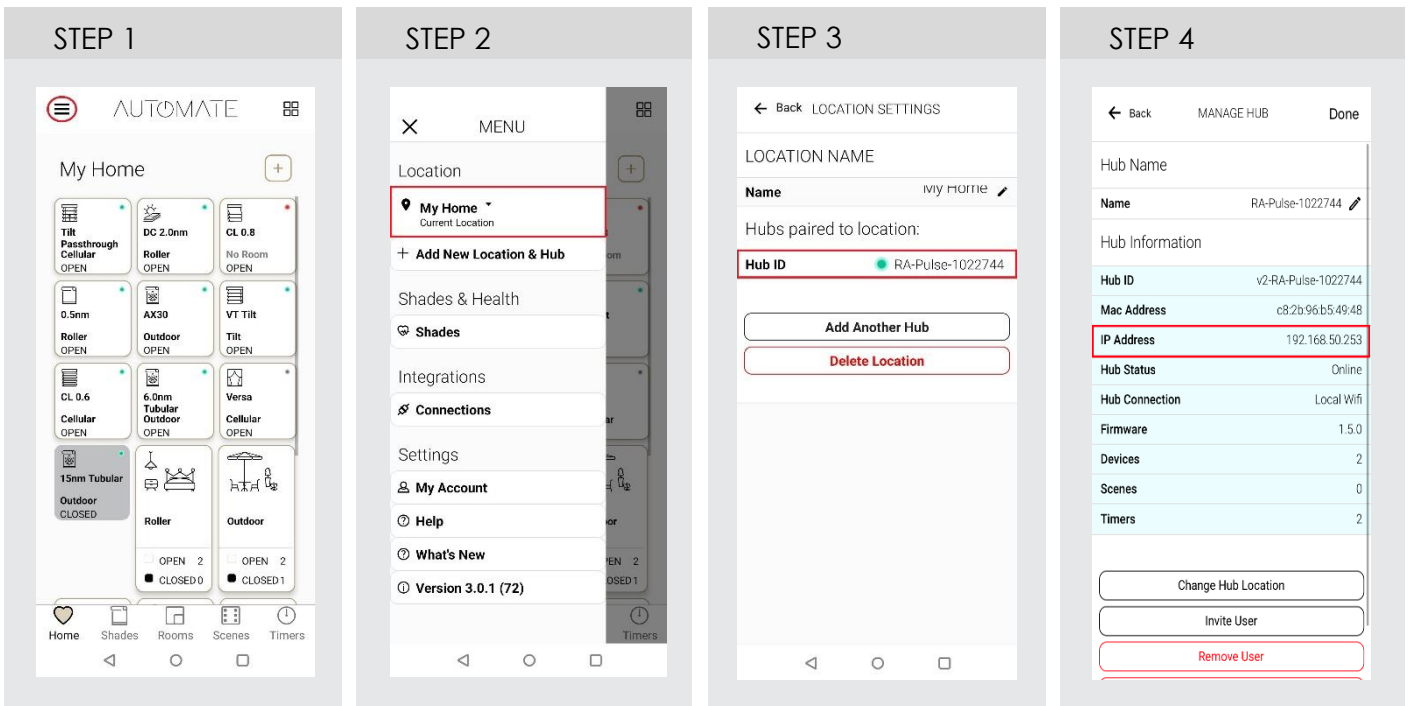

Figure 6: Add the Pulse 2 Hub IP address on Crestron Home System

AUTOMATE™

10.1 Follow below the steps to get the IP address from the Pulse 2 App using the device configuration screen.



11. Press **OK** and the gateway will be added to the selected room. At this point, the gateway will go out and discover all of the motors and a folder of found paired devices will appear in the menu above the TCP Client driver. The name of the folder will reflect the name given to the gateway driver in the previous step.

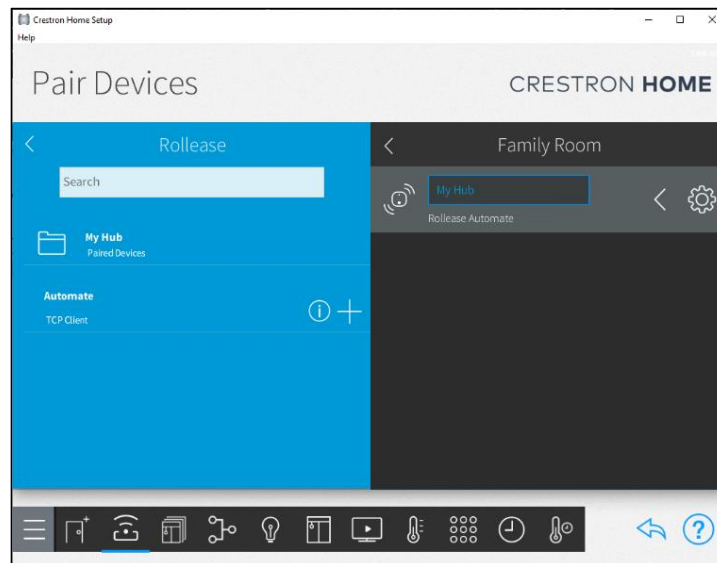

Figure 7: Pulse 2 Hub will auto-discover all the shades paired with Pulse 2 App

12. Press the **Paired Devices** folder to see the discovered motors.

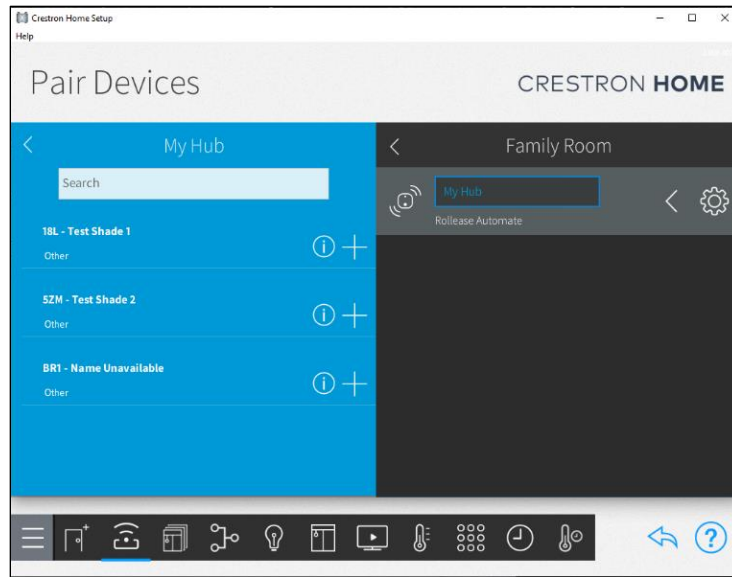

Figure 8: All the shades discovered by Crestron Home.

13. Add device drivers to their corresponding rooms by selecting a room on the right side of the screen, then press the **Plus Sign (+)** next to the driver to add to the selected room. Enter a friendly name for each driver as they are added. Note that as each device is added to a room, it is removed from the folder of detected devices.

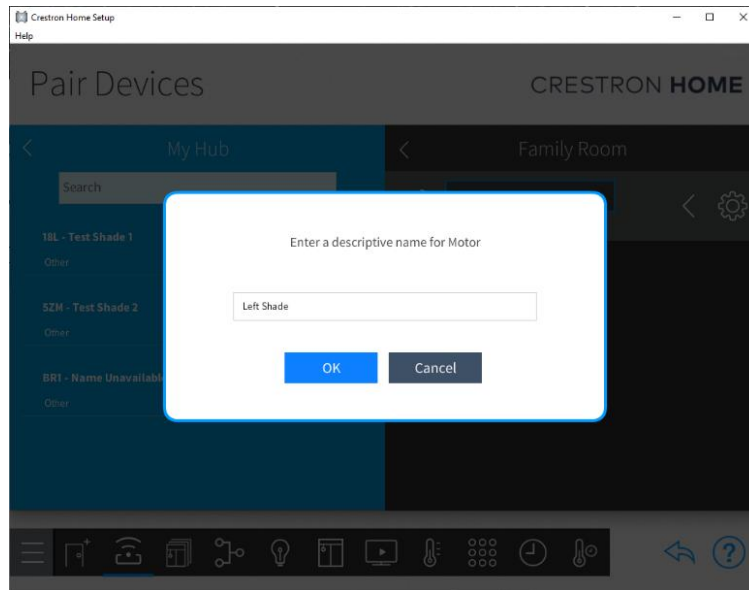



Figure 9: Name the individual shades as you desire. If you prefer to keep the same name as on the Pulse2 App.

When all devices are added, the folder of paired devices is removed. If a device is removed from a room, it will reappear in the paired devices folder and be available to add to a different room.

AUTOMATE™

14. Press the **Actions & Events** button  from the bottom menu bar to navigate to the **Quick Actions** page.
15. Select a room to add quick actions to.

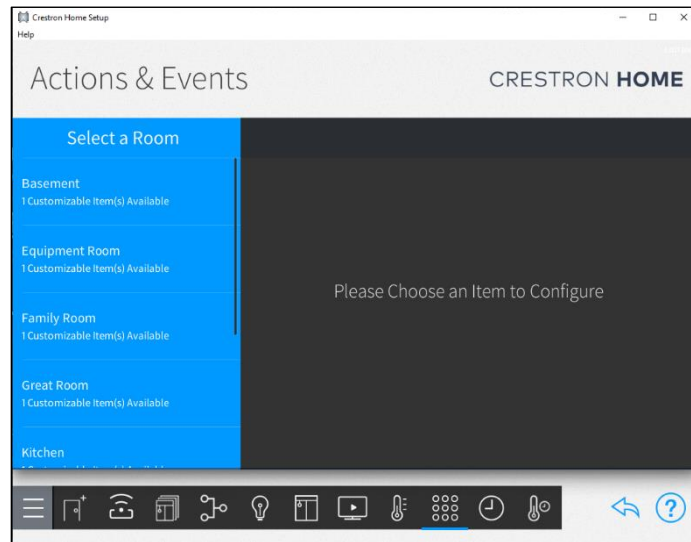
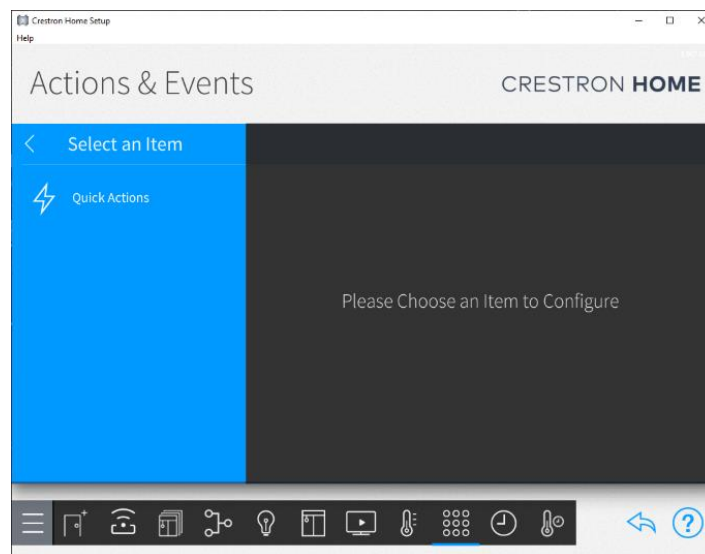

Figure 10: Create Quick Actions as scenes and timers into your Crestron Home.

16. Press the **Quick Actions** menu item to navigate to the **Actions & Events** page for the room you selected.



17. Press the **Plus Sign (+)** next to **Quick Actions** to add a quick action and add a name for the quick action.

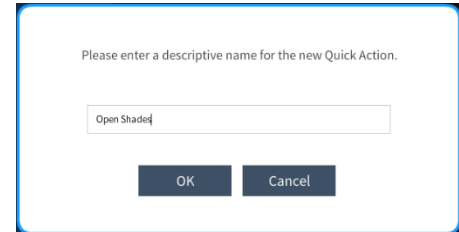
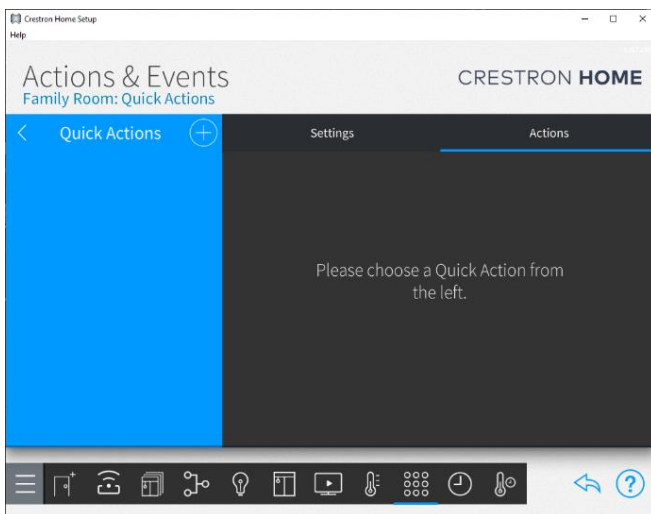
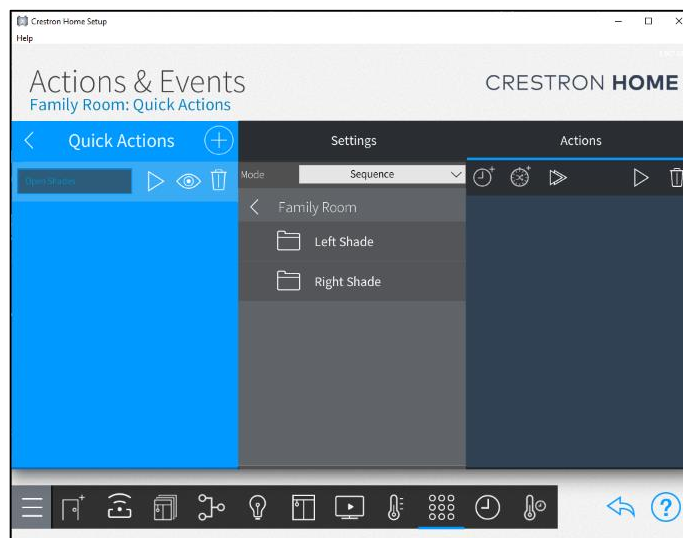

Figure 11: Name the Action on the System to control a group of shades.

18. Select **Sequence** from the **Mode** drop-down menu, then select the room to add the quick action to.



AUTOMATE™

19. Press the name of the device driver, such as **Left Shade**.

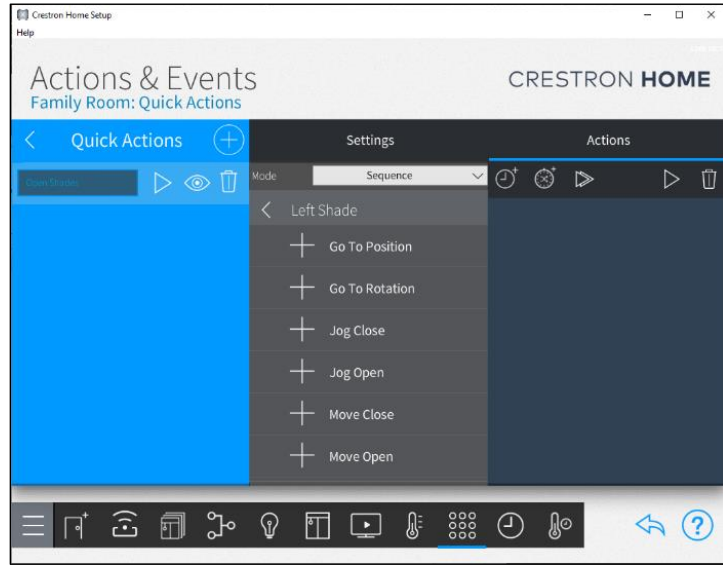

20. Press the **Plus Sign (+)** sign next to the function this quick action will trigger. Observe that the custom feature is added to the sequence of actions. More than one function can be added to the quick action sequence. To remove a function, press the



trash can icon in the Actions menu and press the function to remove.

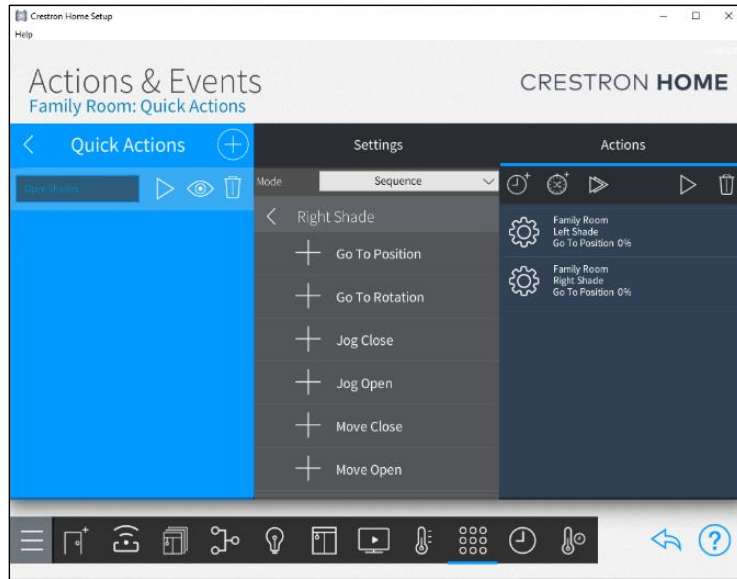

AUTOMATE™

Quick Actions Displayed:

Quick actions will appear in the Crestron Home User App when the room to which the quick actions have been added is displayed.

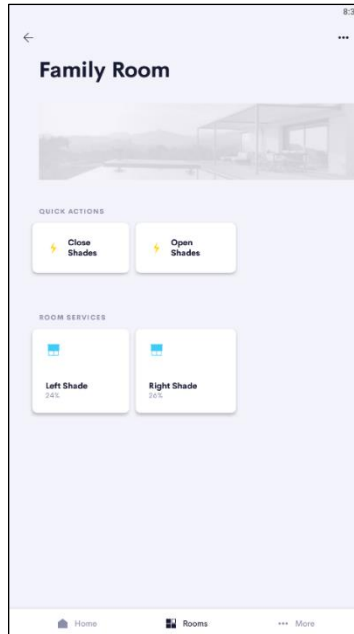
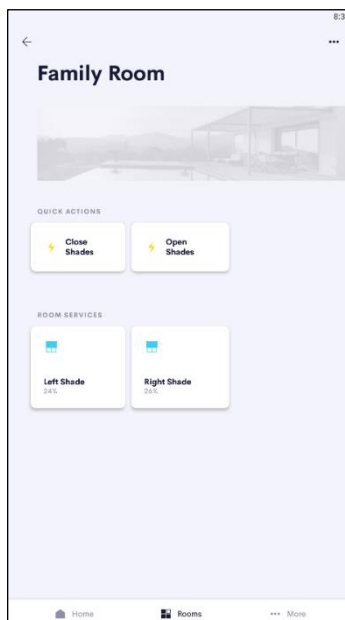

Figure 12: User Experience Interface for individual and group control.

End-User Experience:

The screenshot below shows an example of a room page where a device driver has been added. The room page shows any Quick Actions added to the room for the driver.



AUTOMATE™

The screenshot below shows the shade device control added to the Family Room. This screenshot shows the controls available for the shade.

Due to the ARC Bidirectional communication, all the shade information can be shown in on the Crestron Home Device Control as per below:

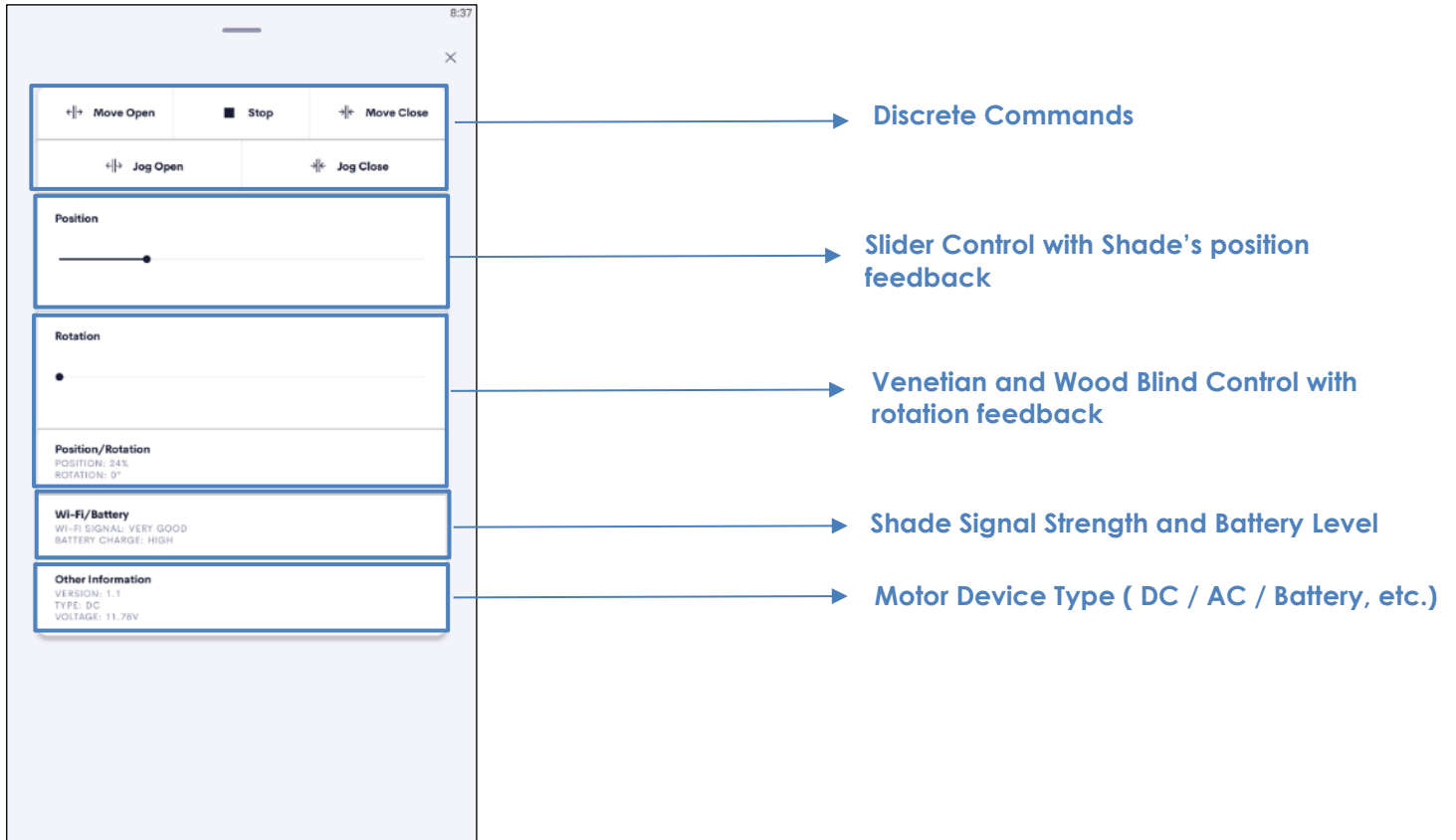

Limitations/Known Issues:

The Rollease Automate Pulse 2 Gateway IP driver is only compatible with Crestron Home.

It is not compatible with: AV Framework or SIMPL Windows.

Supported Features:

The gateway driver has no user-accessible features. The motor driver includes the following features:

Control

- Move Open
- Move Close
- Move Stop
- Jog Open
- Jog Close
- Go to Position
- Go to Rotation

Feedback

- Current Position
- Current Rotation
- Wi-Fi Signal Level
- Battery Charge Level
- Firmware Version
- Charge Type
- Voltage

AUTOMATE™

Test Systems Environment:

The test environment for the driver is as follows:

- Crestron CP4-R v2.45.08.0085
- Crestron Home v3.007.0166
- Crestron Home App v 1.12.17

Rollease Supported Models:

The Rollease Automate Pulse 2 Gateway is the only model gateway this driver supports. All motors that can be added to the Rollease Automate Pulse 2 hub are also supported.

AUTOMATE™

INTEGRATION TOPOLOGY

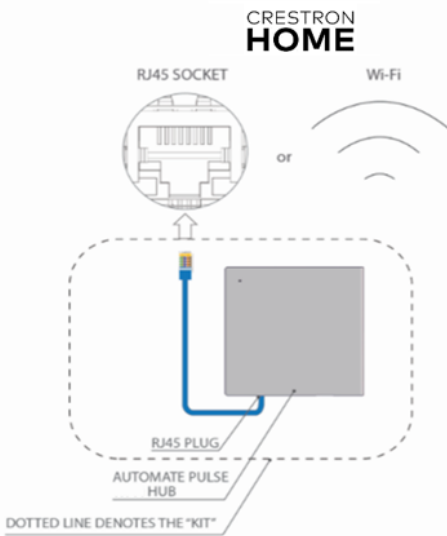

ADDITIONAL INFORMATION:

- The CAT 5 cable should be no longer than 100 meters (328ft).
- Router, switch or access point are required to connect the Hub via LAN connection;
- Wi-fi repeater is required depending on the cover of the Wi-fi Router signal.
- The AUTOMATE PULSE HUB 2 works only with Wi-fi in 2.4Ghz (not 5Ghz)

AUTOMATE PULSE HUB 2

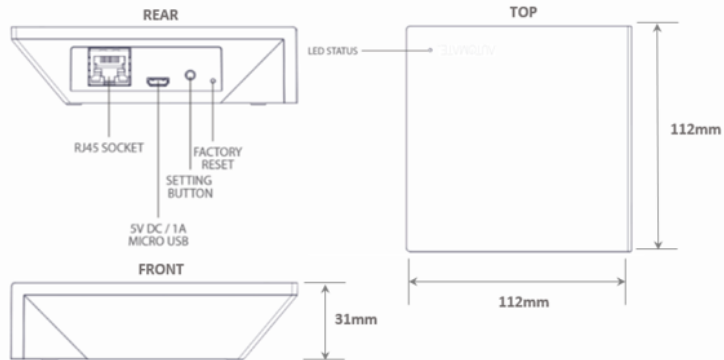

CONNECTIONS

The standard connections of the Automate Pulse Hub 2 is Ethernet or Wi-fi. For a LAN connection, you can use a straight Through wiring accordingly indicated below:

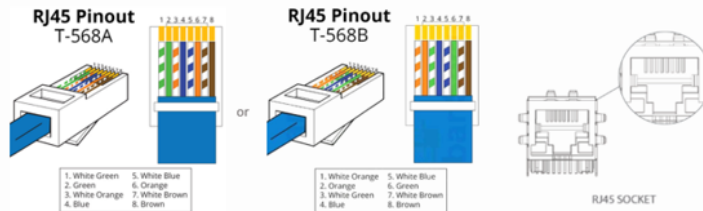

FREQUENTLY ASKED QUESTIONS

Q. No Pulse Hub 2 detected.

A. Make sure that your Automate Pulse 2 is connected to the correct network and get an IP Address available and still communicating with the network using the Automate Pulse App 2.

Q. Shade limits are not set properly.

A. Calibrate shade limits with your Rollease Acmeda remote before setting the appropriate open and close time within Crestron Home SYSTEM.

Q. Shade is not moving at all.

A. Make sure the selected Pulse Hub 2 is the correct Pulse Hub 2 for the shade to be controlled. Confirm the correct bindings are set in the Crestron Home System connections tab between the Pulse Hub 2 and Shade drivers.

Q. I have multiple Pulse Hub's 2, what do I do?

A. Load two Automate Pulse Hub 2 drivers. After selecting "Retrieve Hubs" located in the driver actions tab, you will see different Automate Pulse Hubs 2 - select the desired one.

Q. I do not see any shade bindings in the Pulse Hub 2 driver?

A. Select "Retrieve Shades" located in the driver actions tab.

Q. How do I scan for available Automate Pulse Hub's 2?

A. Once the Automate Pulse Hub 2 is properly connected via the Ethernet cable or Wireless network, navigate to the Automate Pulse Hub 2 Properties page within Composer. Select "Retrieve Hubs" located in the driver actions tab.

Q. We get unexpected responses from the Crestron Home system, or "?" symbols.

A. Ensure that all connections using the ethernet port or Wi-Fi are working properly. The missed connection has been known to yield unwanted or unexpected results.

SUPPORT RESOURCES:

For further assistance, contact your retailer, visit our website at www.automateshades.com.