

S45 AUTOMATE 1.1Nm | 25mm

The motorized 25mm 1.1Nm S45 roller shade system offers two motors for multiple tube diameters to suit a variety of applications. Featuring ARC (Automate Radio Communication), the motorized 25mm 1.1Nm S45 system provides an intelligent, Li-ion battery or DC powered solution.

AESTHETICAL FEATURES

- Thinner 5V Motor Head
- Motor cap to color match with brackets

PRODUCTION & ASSEMBLY FEATURES

- Greater flexibility with installation with extendable pin end
- Crown, drive and adaptors available to suit multiple tube sizes
- Smaller Motor end deduction

FUNCTIONAL BENEFITS

- 5V Micro USB Charging
- Antennae Wire Retention Feature
- Levelling control
- Simple limit setting and adjustment
- Favorite position
- 3 operational speed settings
- 2-WAY RF communication
- ARC protocol for simple programming

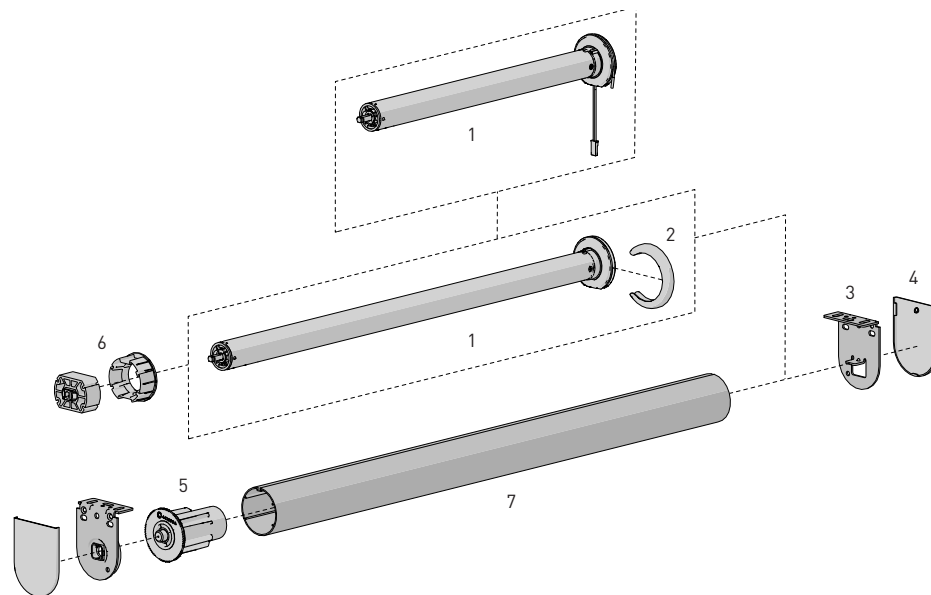

SYSTEM INDEX

1	Automate Motor 25mm MT01-1225-069004 - DCRF 1.1Nm 12V MT01-1325-069017 - Li-ion 1.1Nm 5V ZERO CT20
2	Motor Cap MT03-0502-027001 - Chrome - 5V ZERO ONLY MT03-0502-034001 - Satin Nickel - 5V ZERO ONLY MT03-0502-043001 - Brass - 5V ZERO ONLY MT03-0502-059001 - Black - 5V ZERO ONLY MT03-0502-077001 - White - 5V ZERO ONLY MT03-0502-079001 - Antique Bronze 5V ZERO ONLY MT03-0502-091001 - Gun Metal - 5V ZERO ONLY
3	Brackets RB09-0352-xxx0XX - Li-ion ZERO Brackets RB40-9355-xxx0XX - DCRF Brackets
4	Bracket Covers RB08-4151-xxx0XX RB08-4152-xxx0XX
5	Pin End RB09-0245-xxx001
6	Crown & Drive Set 25mm MT03-0103-069004
7	S45 T-Spline Aluminum Tubes RB93-X443-000490 - Light RB93-X444-000490 - Standard RB93-X449-000490 - Heavy Duty

= Size
xxx = Color
X = catalogue options

COLOUR RANGE



CONTROL OPTIONS

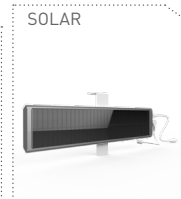
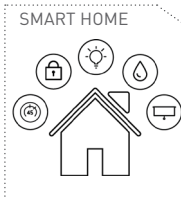

OPTIONS



SYSTEM UPGRADES

- CF90 CASSETTE
- CF90 EDGE
- LINK SYSTEM

SPECIFICATIONS

DEDUCTION CHART

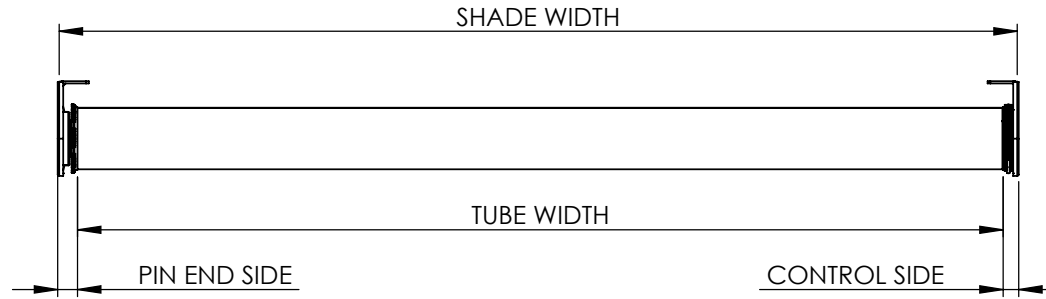

MOTOR	MINIMUM SHADE WIDTH
MT01-1225-069004	15-3/16" [386mm]
MT01-1325-069017	25-1/4" [642mm]

MOTOR	BRACKETS	LIGHT GAP		TUBE DEDUCTION
		CONTROL END	PIN END	
MT01-1225-069004 MT01-1325-069017	With Covers	1/2" [13mm]	9/16" [14mm]	1-1/16" [27mm]
	No Covers	1/2" [12mm]	1/2" [13mm]	1" [25mm]
+ Motor Cap	With Covers	9/16" [14mm]	9/16" [14mm]	1-1/8" [28mm]
	No Covers	1/2" [12mm]	1/2" [13mm]	1" [25mm]

MAX ROLL

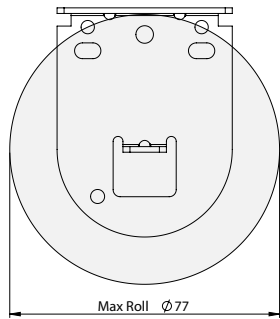

BRACKET	MAX ROLL SIZE
RB09-0352-xxx040	3.03" [77mm]
RB09-0352-xxx050	4.13" [105mm]

TUBE SPECS.

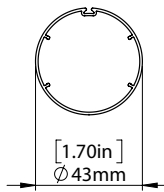

S45 Light Tube

Code RB93-0443-000490
w. tape RB93-6443-000490
Length 16' [4.88m]

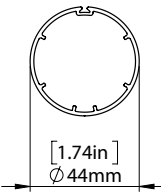

S45 STD Tube

Code RB93-0444-000490
w. tape RB93-6444-000490
Length 16' [4.88m]

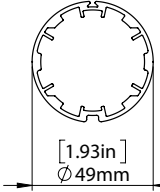

S45 HD Tube

Code RB93-0449-000490
w. tape RB93-6449-000490
Length 16' [4.88m]

MAX LIFTING CAPACITY				MAX DROP**
MOTORS	S45 LT	S45 STD	S45 HD	S45
1.1Nm	11.4lbs [5.2kg]	11.2lbs [5.1kg]	10.1lbs [4.6kg]	13.1' [4m]

Exceeding these value may cause fabric tracking issues

SYSTEM CAPACITY

