

SOLAR POWERED WIND & LIGHT SENSOR

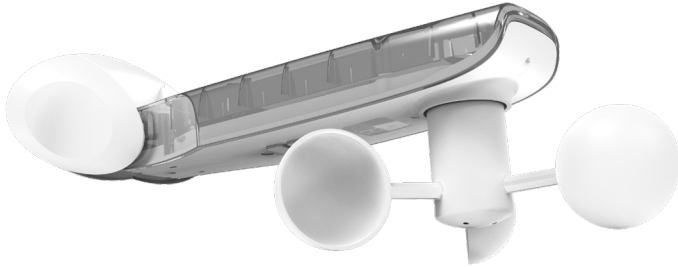

AUTOMATE™ | Wind-Light sensor is a device for measuring wind speed and light intensity. The information is transmitted to ARC outdoor motorized shades that will move to their top or bottom limits.

FEATURES:

- Measure wind speed with an anemometer
- Measure light intensity with a Lux meter
- LCD display
- ARC compatibility
- USB-C Charging Port
- Solar Charging Panel
- Loss of communication Safeguard Technology

SAFETY INSTRUCTIONS

WARNING: Important safety instructions to be read before installation and use.

Incorrect installation or use can lead to serious injury and will void manufacturer's liability and warranty.

It is important for the safety of persons to follow the enclosed instructions. Save these instructions for future reference.

- Do not submerge in water or expose to extreme temperatures.
- Persons (including children) with reduced physical, sensory or mental capabilities, or lack of experience and knowledge should not be allowed to use this product.
- Use or modification outside the scope of this instruction manual will void warranty.
- Installation and programming to be performed by a suitably qualified installer.
- Follow installation instructions.
- For use with motorized shading devices.
- Keep away from children.
- Frequently inspect for improper operation. Do not use if repair or adjustment is necessary.
- Keep clear when in operation.
- Replace battery with correctly specified type.

Rollease Acmeda declares this equipment is in compliance with the essential requirements and other relevant provisions of R&TTE Directive 2014/53/EU

Statement Regarding FCC Compliance

This device complies with Part 15 of the FCC Rules / Innovation, Science and Economic Development Canada's licence-exempt RSS(s). Operation is subject to the following two conditions:

(1) This device may not cause harmful interference, and (2) This device must accept any interference received, including interference that may cause undesired operation.

L'émetteur/récepteur exempt de licence contenu dans le présent appareil est conforme aux CNR d'Innovation, Sciences et Développement économique Canada applicables aux appareils radio exempts de licence. L'exploitation est autorisée aux deux conditions suivantes :

1. L'appareil ne doit pas produire de brouillage; 2. L'appareil doit accepter tout brouillage radioélectrique subi, même si le brouillage est susceptible d'en compromettre le fonctionnement.

Changes or modifications not expressly approved by the party responsible for compliance could void the user's authority to operate the equipment.

Note: This equipment has been tested and found to comply with the limits for a Class B digital device, pursuant to Part 15 of the FCC Rules. These limits are designed to provide reasonable protection against harmful interference in a residential installation. This equipment generates, uses and can radiate radio frequency energy and, if not installed and used in accordance with the instructions, may cause harmful interference to radio communications.

However, there is no guarantee that interference will not occur in a particular installation. If this equipment does cause harmful interference to radio or television reception, which can be determined by turning the equipment off and on, the user is encouraged to try to correct the interference by one or more of the following measures:

- Reorient or relocate the receiving antenna.
- Increase the separation between the equipment and receiver.
- Connect the equipment into an outlet on a circuit different from that to which the receiver is connected.
- Consult the dealer or an experienced radio/TV technician for help.



Do not dispose of in general waste.
Please recycle batteries and damaged electrical products appropriately.



CONTENTS

1	INSTALLATION	4
2	OVERVIEW	5
2.1	Components	5
2.2	LCD Display	6
2.3	Safeguard Technology	6
3	SETUP	7
3.1	Pair the motor to a remote (if required)	7
3.2	Check motor Direction	7
3.3	Pair or Unpair the Sensor to a Motor using a Pre-Paired Remote	8
3.4	Setup wind speed control	8
3.5	Setup light control	9
4	ADDITIONAL FUNCTIONS	10
4.1	Display measured wind speed & light intensity	10
4.2	Display the pre-set threshold value	10
4.3	Wind Sensor Function	11
4.4	Light Sensor Function	11
4.5	Activate/Deactivate Sun & Wind sensor functionality on the motor	12
5	TROUBLESHOOTING	13
6	NOTES	14

1 INSTALLATION

1. Find an appropriate location with direct sunlight and in a location that will see the same wind conditions the paired device will see.
2. Remove the base covers
3. The solar panel must be face up and in direct sunlight
4. Fix the sensor to a suitable surface
5. Re-attach the base covers
6. Ensure the three rotating cups are in an approximately horizontal position

Transmission Distance:

35 meters indoors

200 meters open space

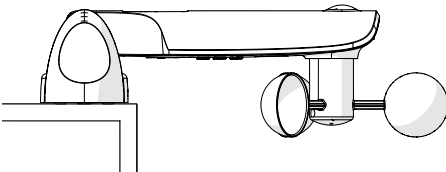
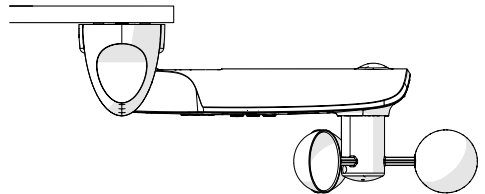
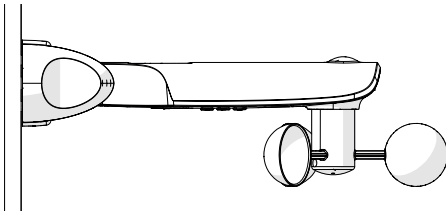
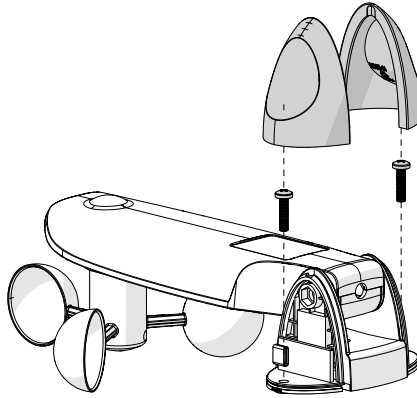

2 OVERVIEW

2.1 COMPONENTS

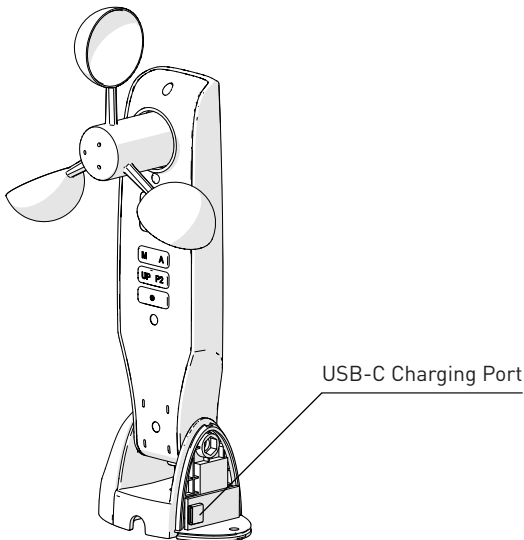
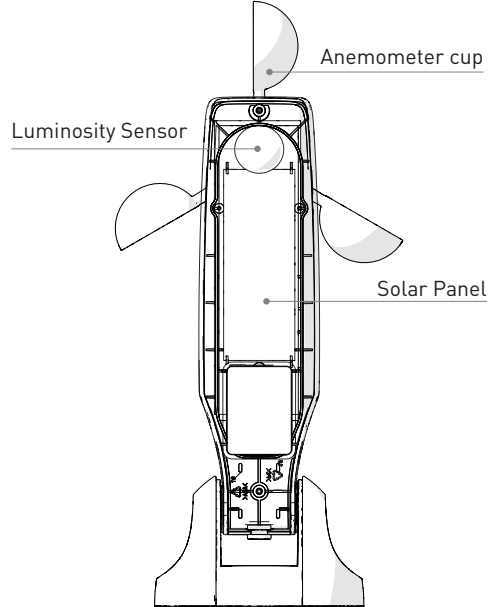
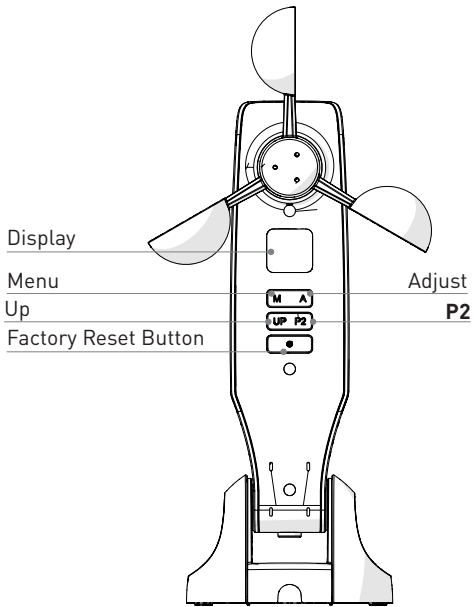

2.2 LCD DISPLAY

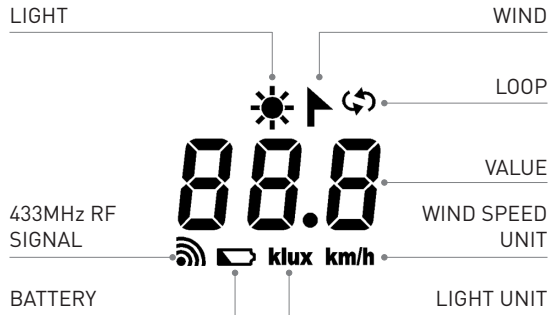

1. The LCD screen lighting stays active for 30 seconds. If there is no operation, the sensor automatically switches its screen off for energy saving, but the program will keep running for normal detection and command transmissions. When the screen is off, pressing any (non-reset) button triggers the screen to be on again for another minute.
2. Sun icon: indicates the light intensity detection mode.
3. Flag icon: indicates the wind speed detection mode.
4. Battery icon: The voltage of the internal battery is checked by its inner program once every day. The appearance of this battery icon indicates that its voltage is below 2.7V. It is recommend that the sensor is placed in direct sunlight or plug in a USB-C cable to charge the sensor for minimum of 6 hours.
5. RF signal icon: displayed when transmitting a signal.

2.3 SAFEGUARD TECHNOLOGY

Once the sensor is paired to an Automate external motor, the sensor will check in with the motor every 30mins.

If the motor does not receive the signal at the checkpoint, the motor will close as a protective measure.

Once the Safeguard feature has been triggered, motor will only move in small increments.

This is a sign that there is a fault in the sensor or that the internal battery has gone flat. If this happens, you will need to place the sensor in direct sunlight or plug in a USB-C cable to charge the sensor for minimum of 6 hours.

3 SETUP

3.1 PAIR THE MOTOR TO A REMOTE (IF REQUIRED)

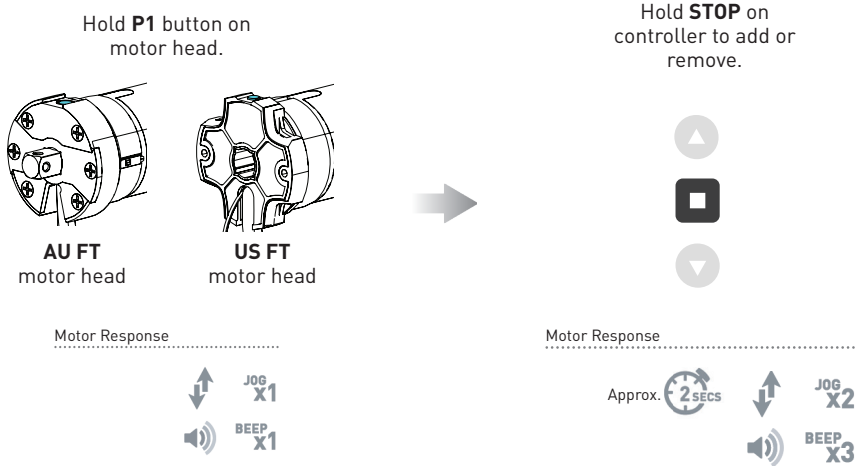

NOTE:

- Complete setup using motor programming instructions.
- The sensor will only work if the motor is configured with the upper and bottom limits.

3.2 CHECK MOTOR DIRECTION

Confirm that motor direction is setup as below so any paired sensors will activate correctly.

DOWN on the remote **OPENS** the Awning (awning moves in an outward/downward direction).

E.g.

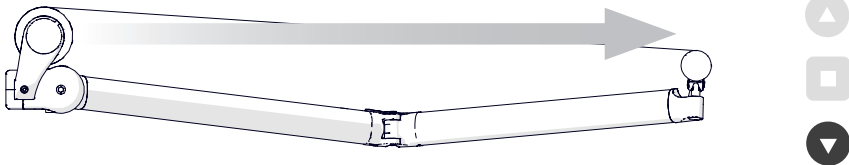

And **UP** on the remote **CLOSES** the Awning (awning moves in an inward/upward direction).

E.g.



Note: Follow motor programming instructions to reverse motor direction if necessary.

3.3 PAIR OR UNAPIR THE SENSOR TO A MOTOR USING A PRE-PAIRED REMOTE

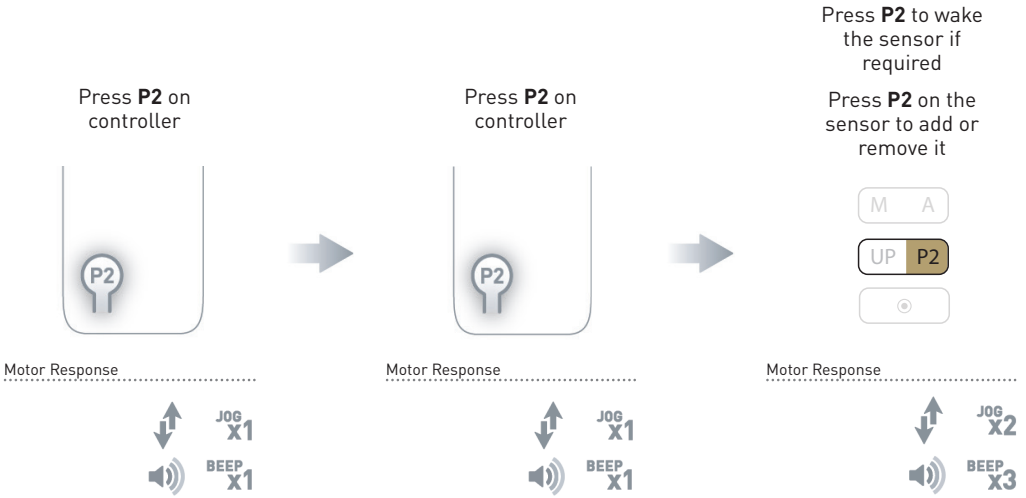

NOTE:

- If the pair is successfully done, the motor can be triggered to move upward by pressing the **UP** button on the sensor.
- Ensure the wind and light sensor functionality on the motor is enabled prior to pairing the wind and sun sensor.
- The pair relationship is kept even if the motor power is reset or the sensor is reset to its default setting.

3.4 SETUP WIND SPEED CONTROL

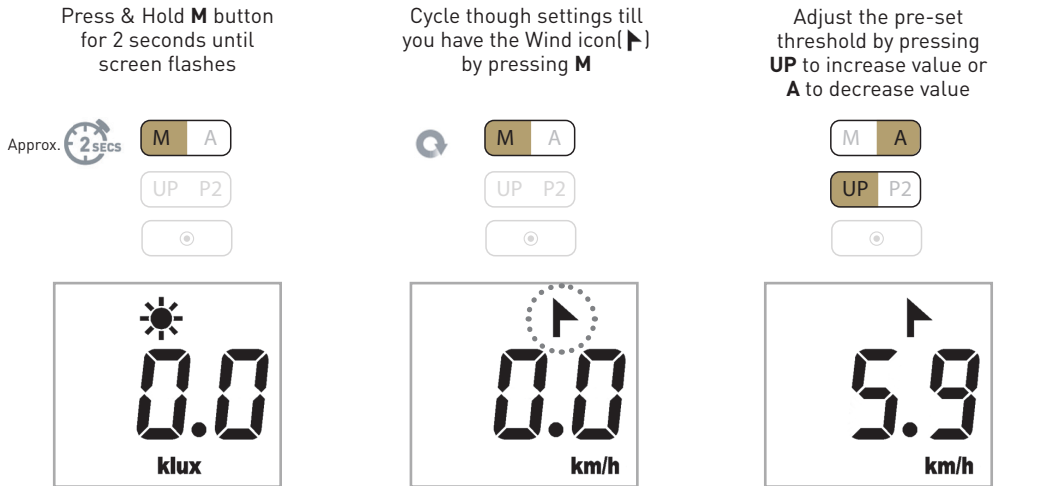

NOTE: The wind speed control function can be disabled by setting its threshold to ZERO. Other threshold values enable this function.

Approx. 10 SECS Wait 10 seconds to set the threshold

3.5 SETUP LIGHT CONTROL

Press & Hold **M** button for 2 seconds until screen flashes

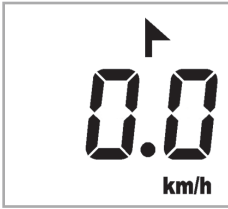

Cycle through settings till you have the Sun icon(☀) by pressing **M**

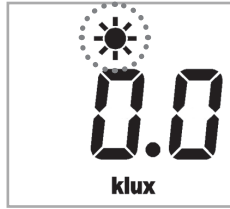
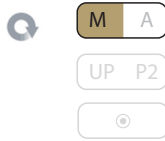

Adjust the pre-set threshold by pressing **UP** to increase value or **A** to decrease value

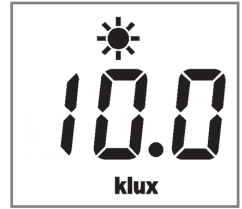

Approx.  Wait 10 seconds to set the threshold

NOTE: The light intensity function can be disabled by setting its threshold to ZERO. Other threshold values enable this function.

Condition	klux (approximate)
Direct Sunlight	100
Daylight	10
Overcast	1



4 ADDITIONAL FUNCTIONS

4.1 DISPLAY MEASURED WIND SPEED & LIGHT INTENSITY

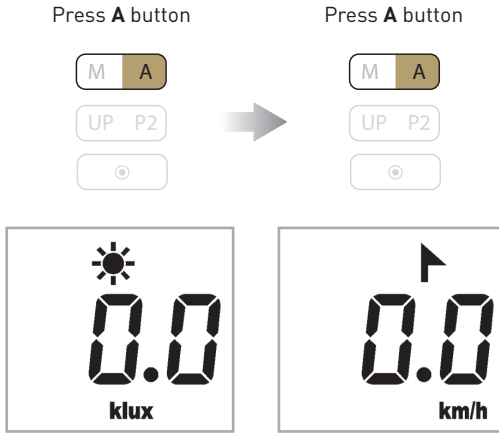
In the sleep mode (blank screen), pressing the Adjust button (A) can loop through light intensity or wind speed. When the loop icon, , is present, the system will automatically display them in a cycle (5 seconds). The sequence is light > wind > loop (light).



4.2 DISPLAY THE PRE-SET THRESHOLD VALUE

Press the MENU button (M) repeatedly to display the pre-set threshold values in a cycle, the corresponding icon,  , flashes to indicate that the pre-setting value is displayed. Pressing the MENU button (M) again returns to the normal mode. The sequence is: display the light intensity threshold value > display the wind speed threshold value > return to normal mode.

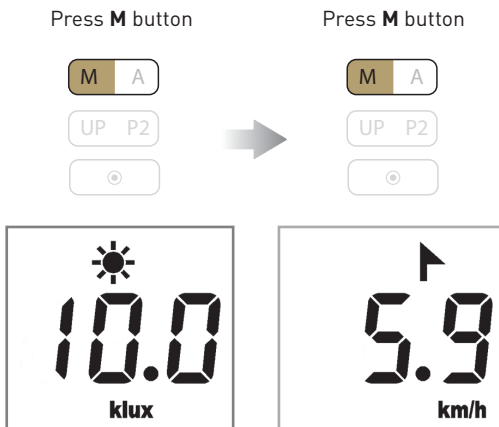

4.3 WIND SENSOR FUNCTION

Wind speed continuously exceeds the threshold value of wind speed for longer than 3 seconds



The sensor command is executed to control the motor "UP" action

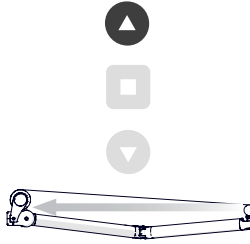

To prevent the motorized shades from frequently opening and closing under a gust, the motor does not operate for next 8 minutes

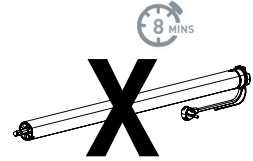

4.4 LIGHT SENSOR FUNCTION

When the environmental light intensity is higher than the threshold for 15 minutes

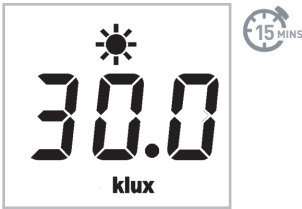

The sensor command is executed to control the motor "DOWN" action

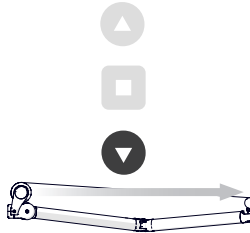

After this period, the sensor temporarily disables its light detection for the next 15 minutes



When the environmental light intensity is lower than the threshold for 15 minutes



The sensor command is executed to control the motor "UP" action

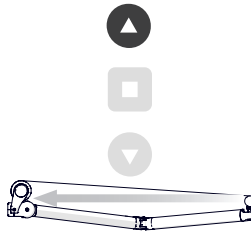

After this period, the sensor temporarily disables its light detection for the next 15 minutes



NOTE :

Wind sensor trigger overrides light sensor, and moves motor up to top limit, despite motor having moved down due to strong light.

4.5 ACTIVATE/DEACTIVATE SUN & WIND SENSOR FUNCTIONALITY ON THE MOTOR

Note: Functionality activated by default.

Press **P2** on controller



Motor Response



Press **UP** on controller



Motor Response



Press **STOP** on controller



Motor Response (Activated)



Motor Response (Deactivated)



5 TROUBLESHOOTING

Problem	Cause	Remedy
Motor is not responding	Sensor battery is discharged	Recharge battery with a USB cable
	Radio interference/Shielding	Ensure transmitter is positioned away from metal objects and that the motor aerial/receiver is kept straight and away from metal
	Receiver distance is too far from transmitter	Move transmitter to a closer position
	Power failure	Check the connection from power supply to motor
	Incorrect wiring	Check if wiring is connected correctly
	Pairing error	Press UP button on sensor to verify pairing
	The motor's function of detecting wind/light is off	Turn on the function
Motor extends then constantly retracts unexpectedly	Wind or light threshold is too low	Increase the threshold to reduce sensitivity
	Extend motorized shade is casting shadow onto sensor	Check & reposition sensor if necessary
Motor does not react to wind or light setting	Wind sensitivity is too high or too low	Adjust sensitivity
	Time interval of strong wind is less than 8 minutes	The wind triggering time length must be over 8 minutes
	Time interval of light is less than 15 minutes	The light triggering time length must be over 15 minutes
Screen not turning on	Internal Battery Flat	Place sensor in direct sunlight or plug in the USB-C connection to charge sensor for minimum of 6 hours.
Motor is only moving in small increments (after motor setup has been completed)	Safeguard feature	Communication between motor and sensor has been lost. Replace the 2 x alkaline batteries and check motion sensor is working correctly.
Motor retracted and not operating (not getting stepping mode function)	Wind Sensor has been triggered	Once the Wind sensor has been triggered there is an 8min lockout as a protective measure.
Safeguard feature is not triggering	Motor and Wind sensor checking timing	Motor and Wind sensor need to have at least 1 check in before this feature is enabled, this occurs every 30mins.

ROLLEASE ACMEDA | USA

Level 7 / 750 East Main Street
Stamford, CT 06902, USA

T +1 800 552 5100 | F +1 203 964 0513

ROLLEASE ACMEDA | AUSTRALIA

110 Northcorp Boulevard,
Broadmeadows VIC 3047, AUS

T +61 3 9355 0100 | F +61 3 9355 0110

ROLLEASE ACMEDA | EUROPE

Via Conca Del Naviglio 18,
Milan (Lombardia) Italy

T +39 02 8982 7317 | F +39 02 8982 7317